



C. Nacional de Juvenis Juniores e Seniores Formas Equipas Mão Vazia | Open | 30-65 Years

007

Final

	Pedro Mendes, André Nunes, Valter Frade (AKMPT)	<input type="text"/>	<input type="text"/>	<input type="text"/>
	Tiago Soares, José Santos, André Doutor (AMAVEIRO)	<input type="text" value="1"/>	<input type="text" value="1"/>	<input type="text" value="1"/>

D1 - A1 - Morning

1° Tiago Soares, José Santos, André Doutor (AMAVEIRO)

2° Pedro Mendes, André Nunes, Valter Frade (AKMPT)

Note

NoneAREA: None

C. Nacional de Juvenis Juniores e Seniores

Formas Equipas Mão Vazia | Open | 14-15 Years

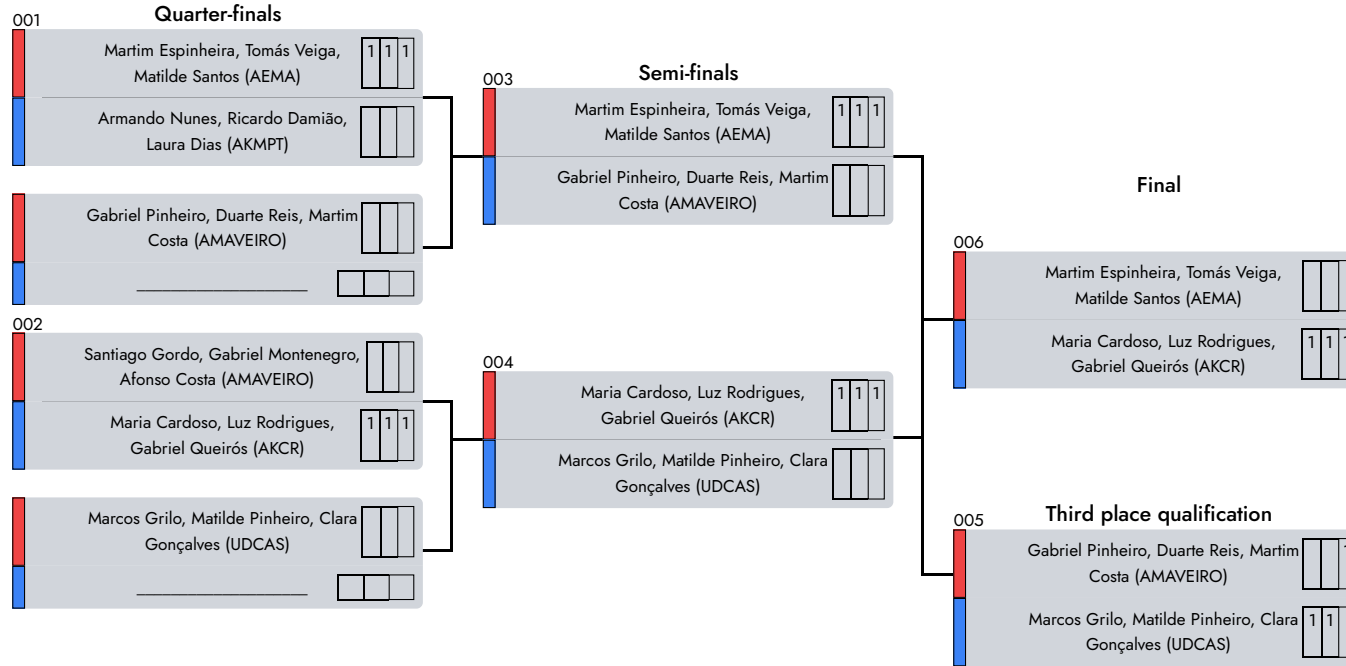

D1 - A1 - Morning

1° Maria Cardoso, Luz Rodrigues, Gabriel Queirós (AKCR)

2° Martim Espinheira, Tomás Veiga, Matilde Santos (AEMA)

3° Marcos Grilo, Matilde Pinheiro, Clara Gonçalves (UDCAS)

Note
 NoneAREA: None
 AREA: None

Judge 1

Central Referee

Judge 2

C. Nacional de Juvenis Juniores e Seniores

Formas de Equipas Com Armas | Open | 30-65 Years

008

Final

Carolina Taborda, Marina Cardona, Emanuel Taborda (CAMCTO)

0

Tiago Soares, José Santos, André Doutor (AMAVEIRO)

3

D1 - A1 - Morning

1° Tiago Soares, José Santos, André Doutor (AMAVEIRO)

2° Carolina Taborda, Marina Cardona, Emanuel Taborda (CAMCTO)

Note

NoneAREA: None

Judge 1

Central Referee

Judge 2

C. Nacional de Juvenis Juniores e Seniores

Formas de Equipas Com Armas | Open | 14-15 Years

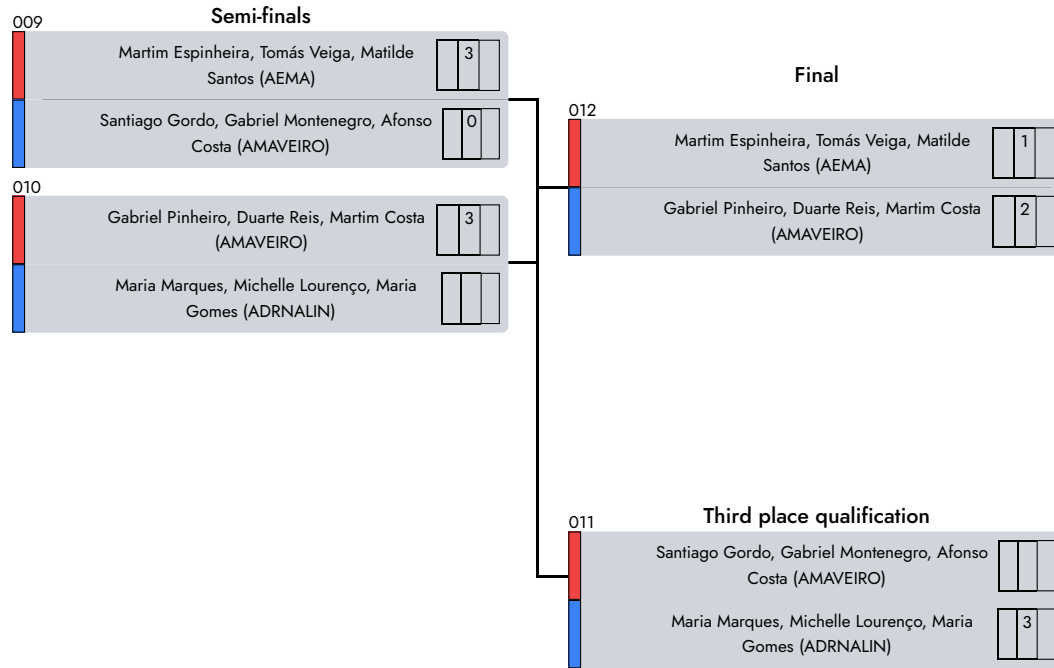

D1 - A1 - Morning

1° Gabriel Pinheiro, Duarte Reis, Martim Costa (AMAVEIRO)

2° Martim Espinheira, Tomás Veiga, Matilde Santos (AEMA)

3° Maria Marques, Michelle Lourenço, Maria Gomes (ADRNALIN)

Note
 NoneAREA: None

Judge 1

Central Referee

Judge 2

C. Nacional de Juvenis Juniores e Seniores

Defesa Pessoal | Open | 14-17 Years

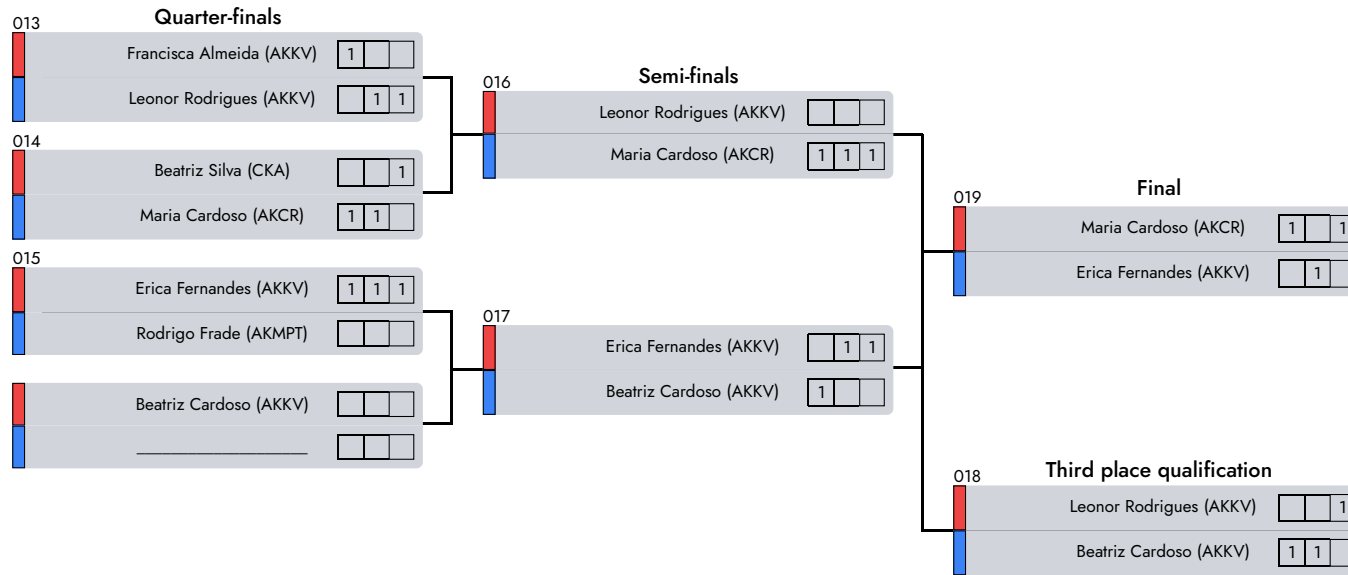

D1 - A1 - Morning

1° Maria Cardoso (AKCR)

2° Erica Fernandes (AKKV)

3° Beatriz Cardoso (AKKV)

Note
 NoneAREA: None
 AREA: None

Judge 1

Central Referee

Judge 2

C. Nacional de Juvenis Juniores e Seniores

Formas Mão Vazia | Masculine | 14-15 Years

D1 - A1 - Morning

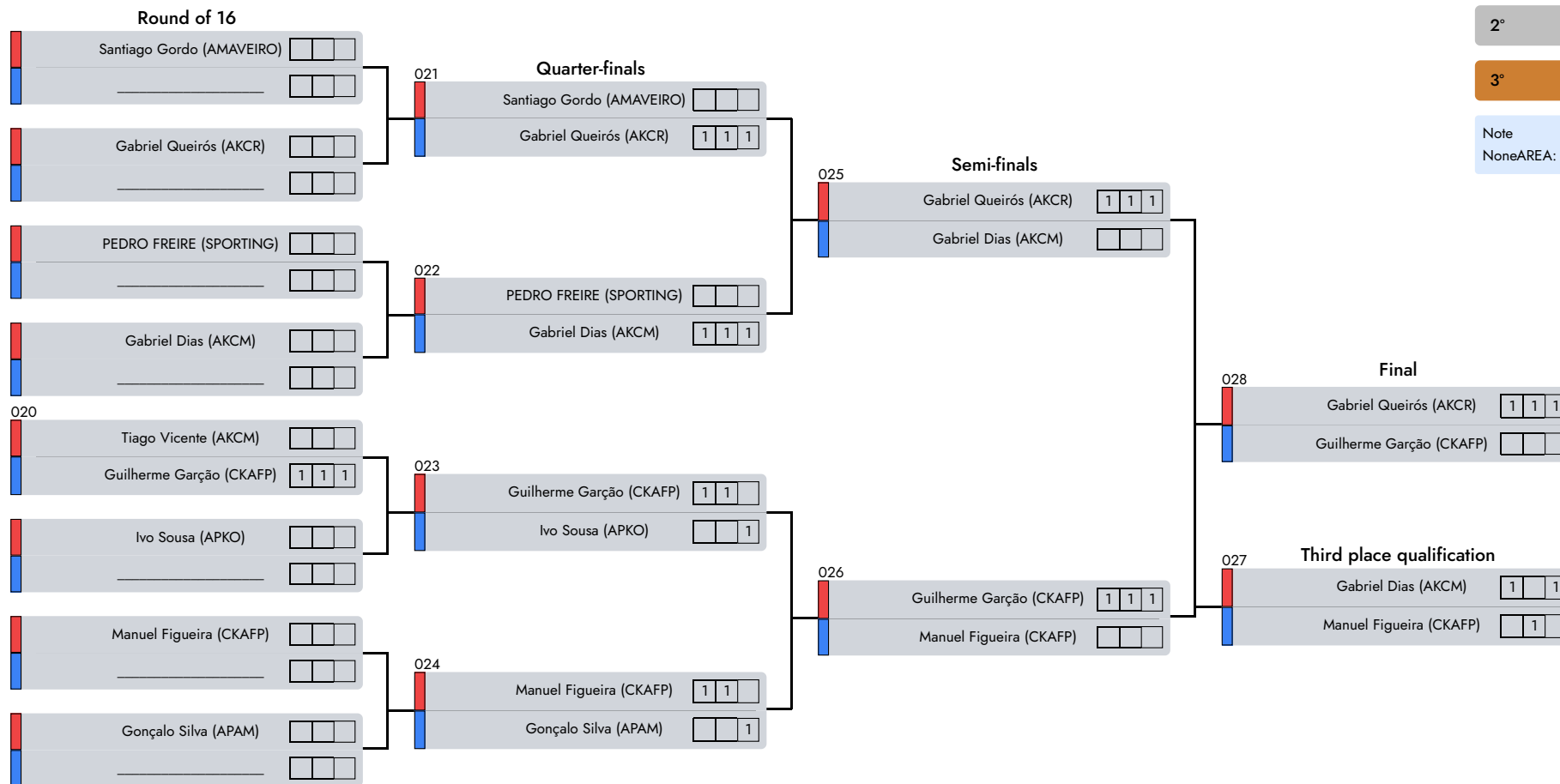

1° Gabriel Queirós (AKCR)

2° Guilherme Garção (CKAFP)

3° Gabriel Dias (AKCM)

Note
NoneAREA: None

Judge 1

Central Referee

Judge 2

C. Nacional de Juvenis Juniores e Seniores

Formas Mão Vazia | Masculine | 18-29 Years

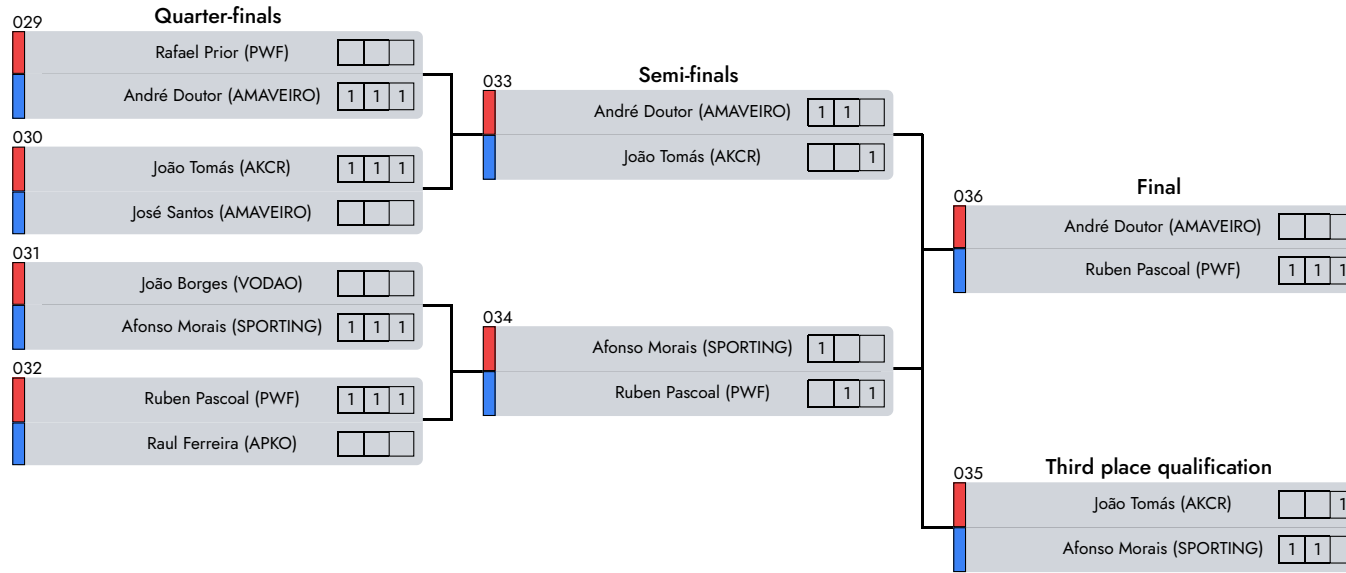

D1 - A1 - Morning

1° Ruben Pascoal (PWF)

2° André Doutor (AMAVEIRO)

3° Afonso Morais (SPORTING)

Note
NoneAREA: None

Judge 1

Central Referee

Judge 2

C. Nacional de Juvenis Juniores e Seniores

Formas c/ Armas | Masculine | 14-15 Years

D1 - A1 - Morning

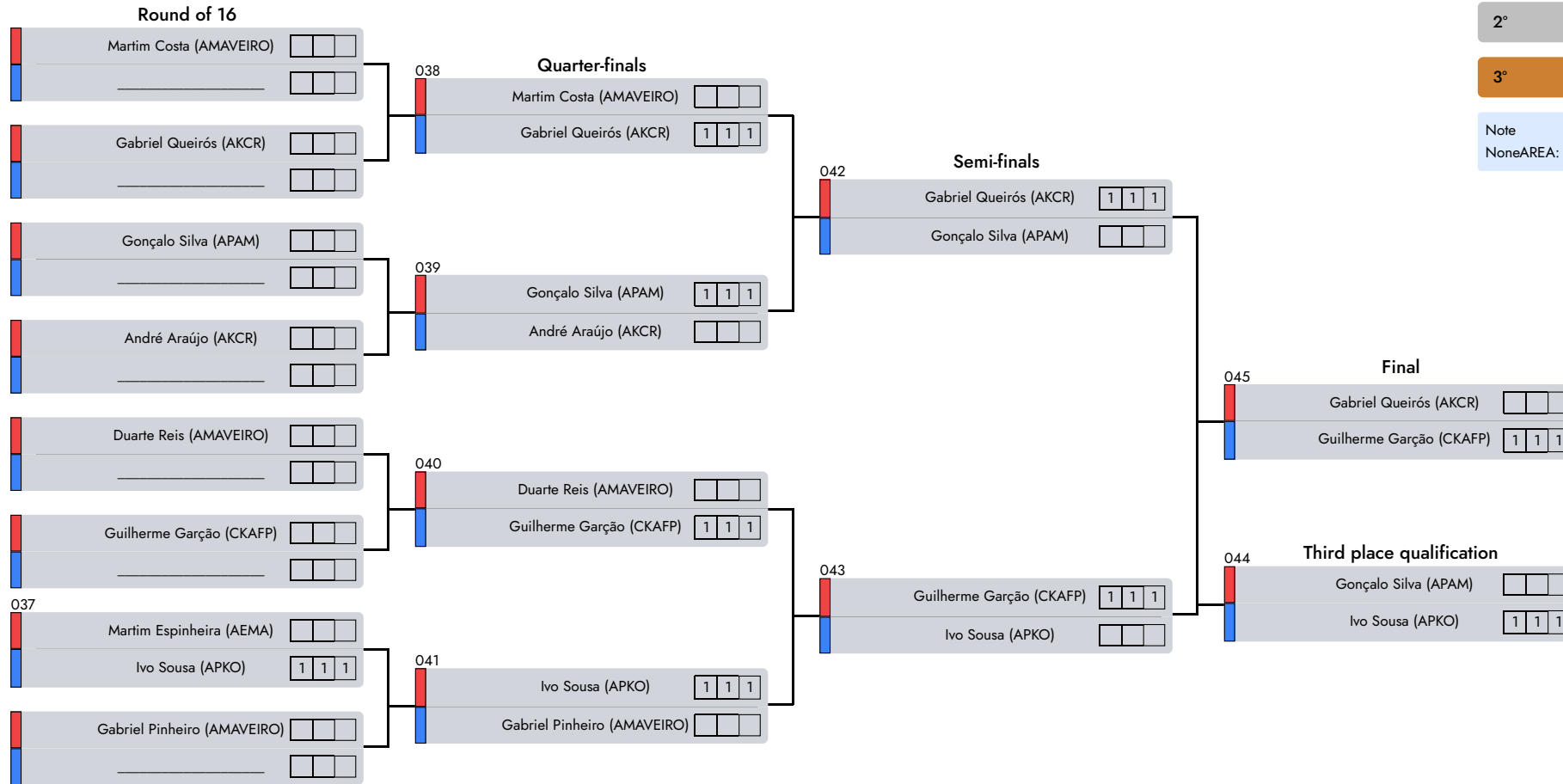

1° Guilherme Garção (CKAFP)

2° Gabriel Queirós (AKCR)

3° Ivo Sousa (APKO)

Note
NoneAREA: None

Judge 1

Central Referee

Judge 2

C. Nacional de Juvenis Juniores e Seniores

Formas c/ Armas | Masculine | 18-29 Years

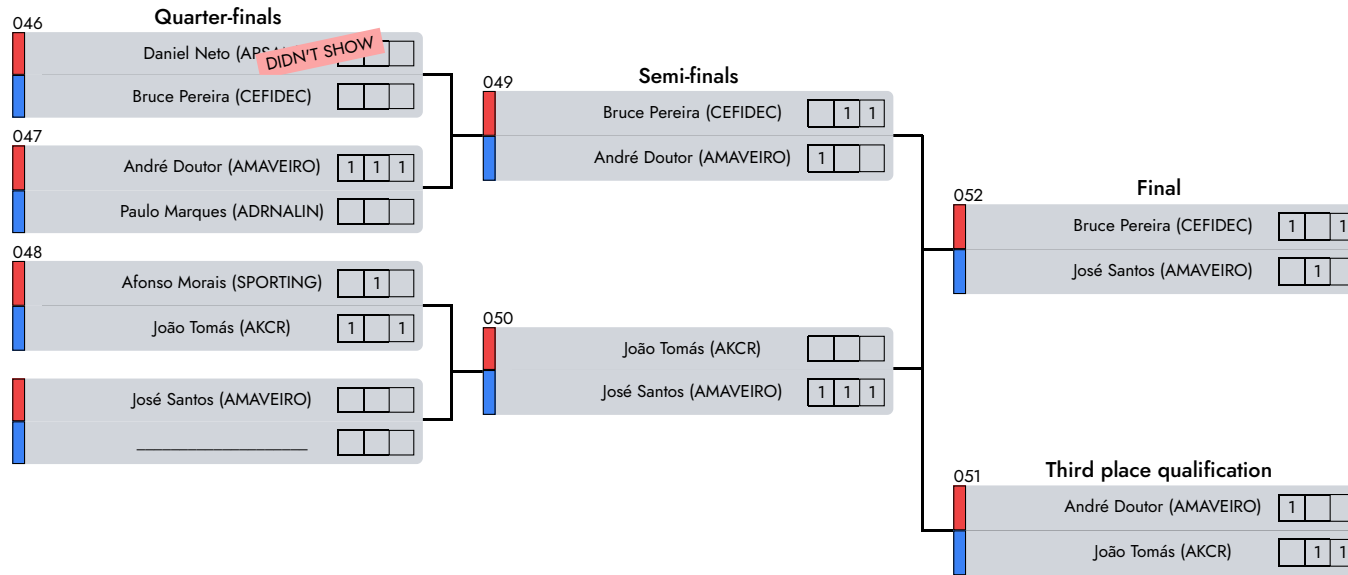

D1 - A1 - Morning

1° Bruce Pereira (CEFIDEC)

2° José Santos (AMAVEIRO)

3° João Tomás (AKCR)

Note
NoneAREA: None
AREA: None

Judge 1

Central Referee

Judge 2

C. Nacional de Juvenis Juniores e Seniores

Formas Equipas Mão Vazia | Open | 18-29 Years

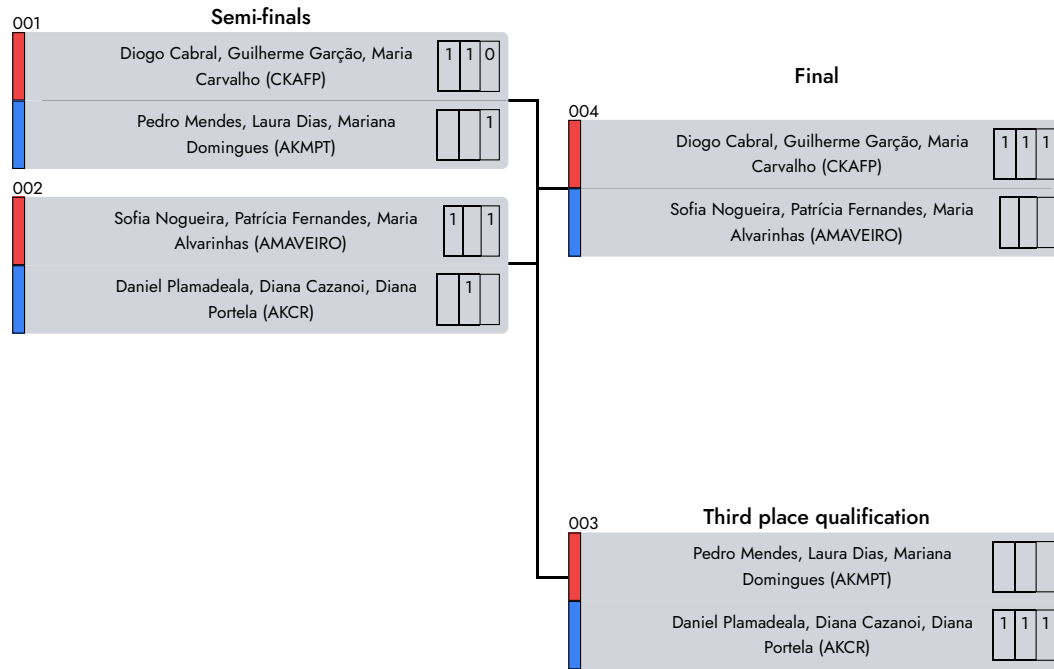

D1 - A2 - Morning

1° Diogo Cabral, Guilherme Garção, Maria Carvalho (CKAFP)

2° Sofia Nogueira, Patrícia Fernandes, Maria Alvarinhas (AMAVEIRO)

3° Daniel Plamadeala, Diana Cazanoi, Diana Portela (AKCR)

Note
NoneAREA: None

Judge 1

Central Referee

Judge 2

C. Nacional de Juvenis Juniores e Seniores

Formas de Equipas Com Armas | Open | 16-17 Years

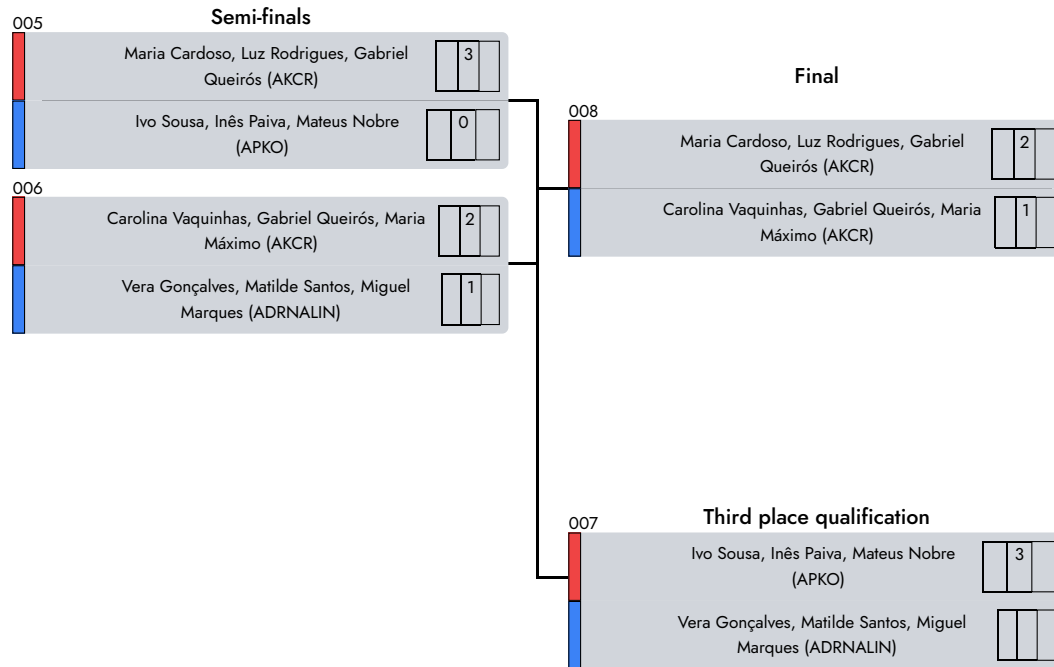

D1 - A2 - Morning

1° Maria Cardoso, Luz Rodrigues, Gabriel Queirós (AKCR)

2° Carolina Vaquinhas, Gabriel Queirós, Maria Máximo (AKCR)

3° Ivo Sousa, Inês Paiva, Mateus Nobre (APKO)

Note
 NoneAREA: None
 AREA: None

Judge 1

Central Referee

Judge 2

C. Nacional de Juvenis Juniores e Seniores

Formas de Equipas Com Armas | Open | 18-29 Years

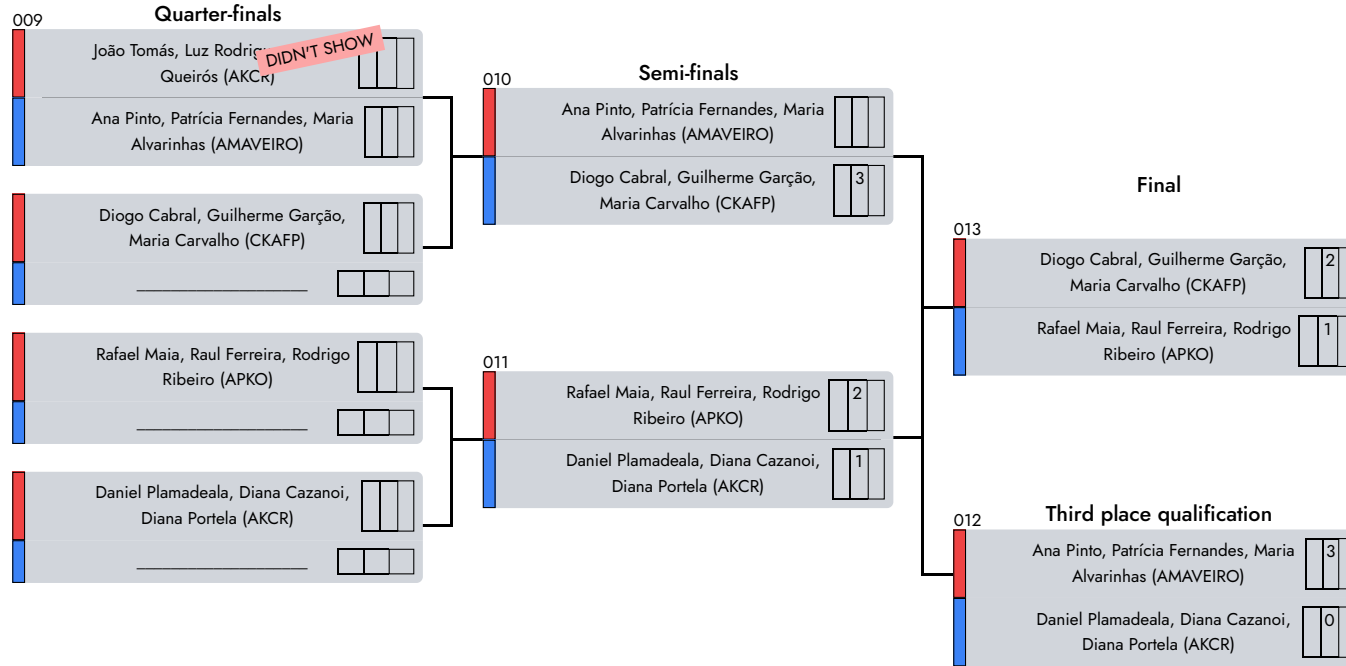

D1 - A2 - Morning

1° Diogo Cabral, Guilherme Garção, Maria Carvalho (CKAFP)

2° Rafael Maia, Raul Ferreira, Rodrigo Ribeiro (APKO)

3° Ana Pinto, Patrícia Fernandes, Maria Alvarinhas (AMAVEIRO)

Note
NoneAREA: None

Judge 1

Central Referee

Judge 2

C. Nacional de Juvenis Juniores e Seniores

Defesa Pessoal | Open | 18-29 Years

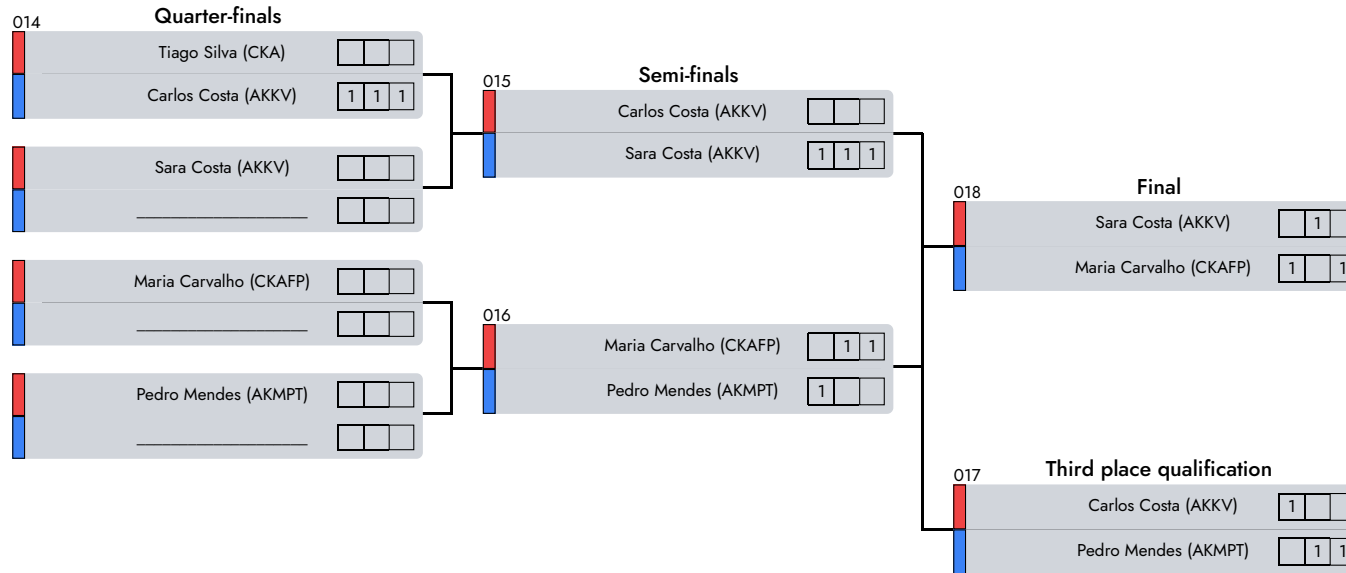

D1 - A2 - Morning

- 1° Maria Carvalho (CKAFP)
 - 2° Sara Costa (AKKV)
 - 3° Pedro Mendes (AKMPT)
- Note
NoneAREA: None

Judge 1

Central Referee

Judge 2

C. Nacional de Juvenis Juniores e Seniores

Formas Mão Vazia | Feminine | 14-15 Years

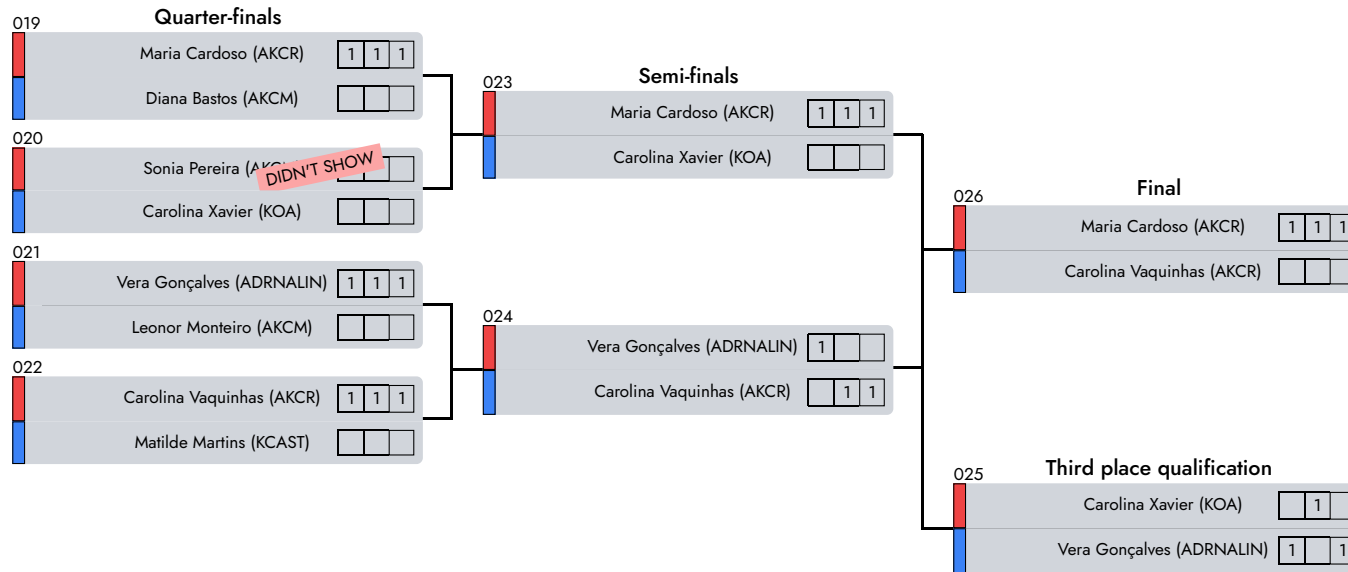

D1 - A2 - Morning

1° Maria Cardoso (AKCR)

2° Carolina Vaquinhas (AKCR)

3° Vera Gonçalves (ADRNALIN)

Note
NoneAREA: None

Judge 1

Central Referee

Judge 2

C. Nacional de Juvenis Juniores e Seniores

Formas Mão Vazia | Feminine | 18-29 Years

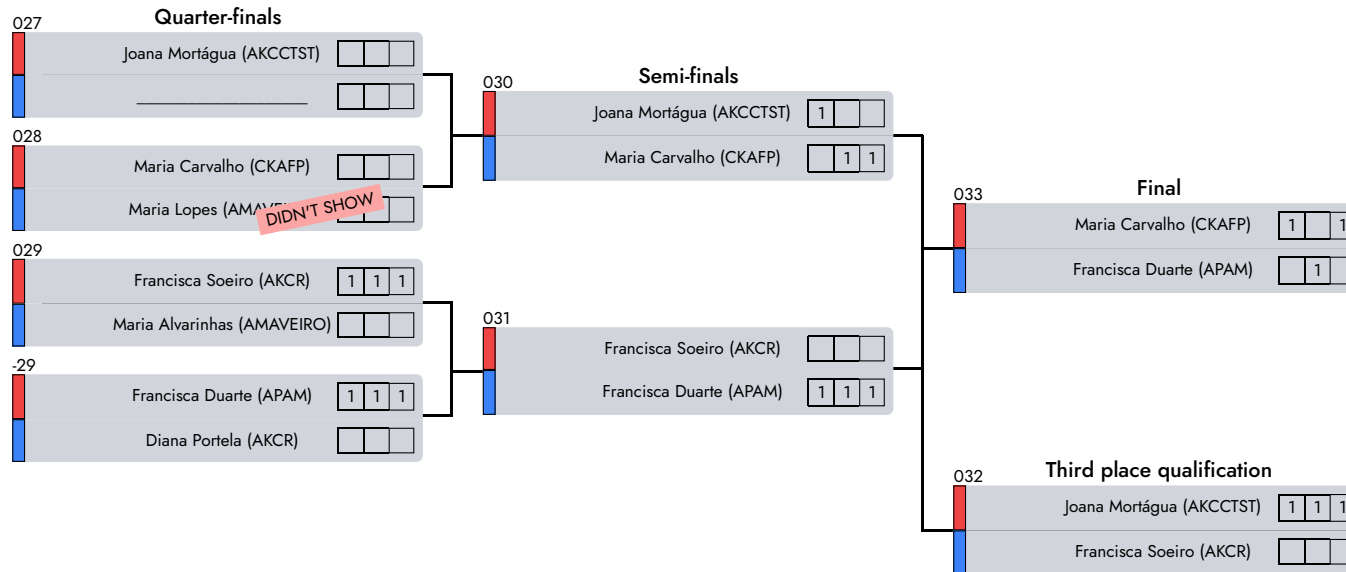

D1 - A2 - Morning

1° Maria Carvalho (CKAFP)

2° Francisca Duarte (APAM)

3° Joana Mortágua (AKCCTST)

Note
NoneAREA: None

Judge 1

Central Referee

Judge 2

C. Nacional de Juvenis Juniores e Seniores

Formas c/ Armas | Feminine | 14-15 Years

D1 - A2 - Morning

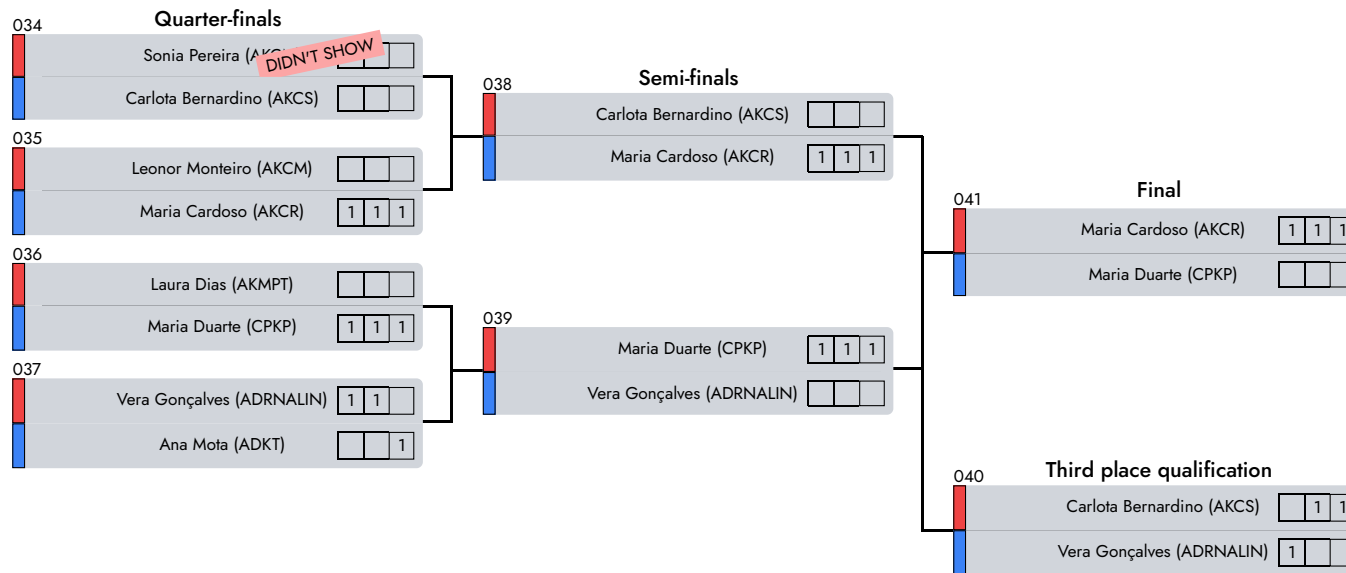

- 1° Maria Cardoso (AKCR)
 - 2° Maria Duarte (CPKP)
 - 3° Carlota Bernardino (AKCS)
- Note
NoneAREA: None

Judge 1

Central Referee

Judge 2

C. Nacional de Juvenis Juniores e Seniores

Formas c/ Armas | Feminine | 18-29 Years

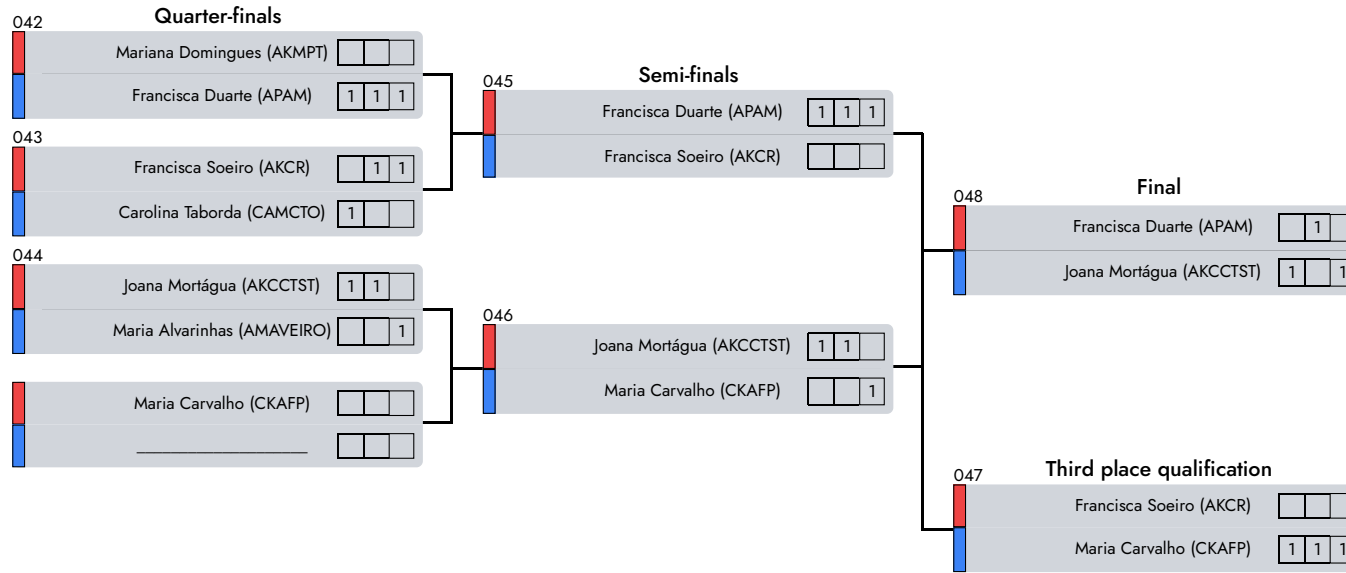

- D1 - A2 - Morning**
- 1° Joana Mortágua (AKCCTST)
 - 2° Francisca Duarte (APAM)
 - 3° Maria Carvalho (CKAFP)
- Note
NoneAREA: None
AREA: None

Judge 1

Central Referee

Judge 2

C. Nacional de Juvenis Juniores e Seniores

Formas de Mão Vazia Adaptado | Masculine | 40-65 Years

D1 - A3 - Morning

001

Final

Emanuel Santinho (CERCIG)

--	--	--

Bruno Costa (CERCIG)

--	--	--

1° _____

2° _____

Note

No notes



Judge 1

Central Referee

Judge 2

C. Nacional de Juvenis Juniores e Seniores

Formas de Mão Vazia Adaptado | Masculine | 11-13 Years

Final	
002	
	Sérgio Holban (AKKL) <input type="text"/> <input type="text"/> <input type="text"/>
	João Jorge (AKCRM) <input type="text"/> 1 <input type="text"/> 1 <input type="text"/> 1
003	
	Sérgio Holban (AKKL) <input type="text"/> <input type="text"/> <input type="text"/>
	Leonardo Tavares (CKAFP) <input type="text"/> 1 <input type="text"/> 1 <input type="text"/> 1
004	
	João Jorge (AKCRM) <input type="text"/> <input type="text"/> <input type="text"/>
	Leonardo Tavares (CKAFP) <input type="text"/> 1 <input type="text"/> 1 <input type="text"/> 1

D1 - A3 - Morning

1° Leonardo Tavares (CKAFP)

2° João Jorge (AKCRM)

3° Sérgio Holban (AKKL)

Note

NoneAREA: None

Judge 1

Central Referee

Judge 2

C. Nacional de Juvenis Juniores e Seniores

Formas de Mão Vazia Adaptado | Masculine | 14-15 Years

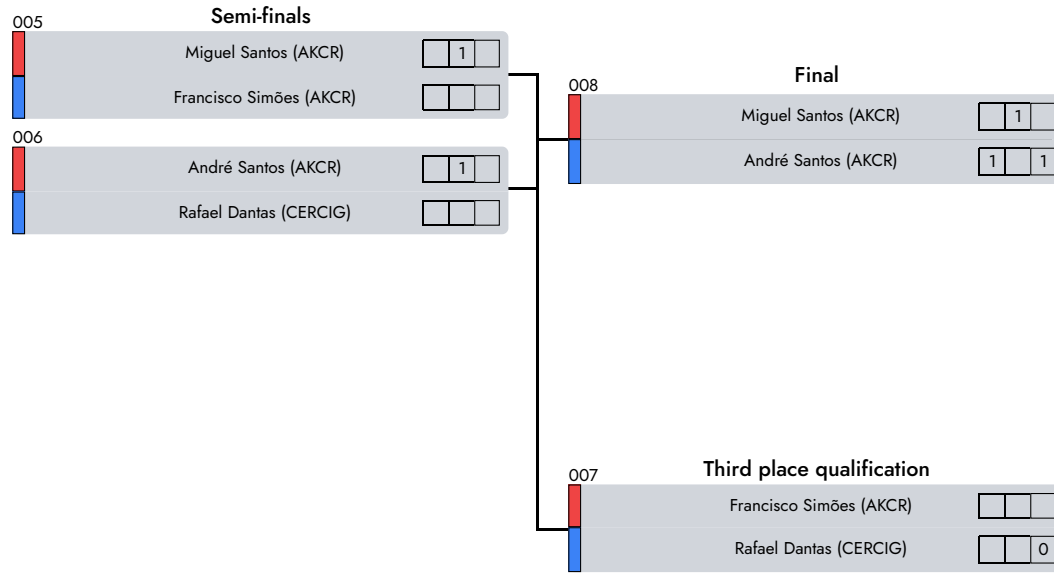

D1 - A3 - Morning

1° André Santos (AKCR)

2° Miguel Santos (AKCR)

3° Rafael Dantas (CERCIG)

Note
NoneAREA: None



Judge 1

Central Referee

Judge 2

C. Nacional de Juvenis Juniores e Seniores

Formas c/ Armas Adaptado | Masculine | 11-13 Years

Final	
010	
	Leonardo Tavares (CKAFP) <input type="text" value="1"/> <input type="text" value="1"/> <input type="text" value="1"/>
	João Jorge (AKCRM) <input type="text" value=""/> <input type="text" value=""/> <input type="text" value=""/>
011	
	Leonardo Tavares (CKAFP) <input type="text" value="1"/> <input type="text" value="1"/> <input type="text" value="1"/>
	Sérgio Holban (AKKL) <input type="text" value=""/> <input type="text" value=""/> <input type="text" value=""/>
012	
	João Jorge (AKCRM) <input type="text" value=""/> <input type="text" value=""/> <input type="text" value=""/>
	Sérgio Holban (AKKL) <input type="text" value="1"/> <input type="text" value="1"/> <input type="text" value="1"/>

D1 - A3 - Morning

1° Leonardo Tavares (CKAFP)

2° Sérgio Holban (AKKL)

3° João Jorge (AKCRM)

Note

NoneAREA: None

Judge 1

Central Referee

Judge 2

C. Nacional de Juvenis Juniores e Seniores

Formas de Mão Vazia Adaptado | Masculine | 30-39 Years

009

Final

Jorge Brigas (CERCIG)

DIDN'T SHOW

João Garcia (CERCIG)

D1 - A3 - Morning

1° João Garcia (CERCIG)

2° Jorge Brigas (CERCIG)

Note

NoneAREA: None

Judge 1

Central Referee

Judge 2

C. Nacional de Juvenis Juniores e Seniores

Kempo Desportivo Adaptado | Masculine | 16-17 Years | -73 Kg

016

Final

Miguel Santos (AKCR)

--	--	--

André Santos (AKCR)

--	--	--

D1 - A3 - Morning

1°

Miguel Santos (AKCR)

2°

André Santos (AKCR)

Note

NoneAREA: None

Judge 1

Central Referee

Judge 2

C. Nacional de Juvenis Juniores e Seniores

Kempo Desportivo Adaptado | Masculine | 18-40 Years | -66 Kg

Final	
013	
	Jorge Brigas (CERCIG) DIDN'T SHOW <input type="checkbox"/> <input type="checkbox"/> <input type="checkbox"/>
	João Garcia (CERCIG) <input type="checkbox"/> <input type="checkbox"/> <input type="checkbox"/>
014	
	Jorge Brigas (CERCIG) DIDN'T SHOW <input type="checkbox"/> <input type="checkbox"/> <input type="checkbox"/>
	Rafael Dantas (CERCIG) <input type="checkbox"/> <input type="checkbox"/> <input type="checkbox"/>
015	
	João Garcia (CERCIG) <input type="checkbox"/> <input type="checkbox"/> <input type="checkbox"/>
	Rafael Dantas (CERCIG) DIDN'T SHOW <input type="checkbox"/> <input type="checkbox"/> <input type="checkbox"/>

D1 - A3 - Morning

1° João Garcia (CERCIG)

2° Rafael Dantas (CERCIG)

3° _____

Note

NoneAREA: None

Judge 1

Central Referee

Judge 2

C. Nacional de Juvenis Juniores e Seniores Semi Kempo | Feminine | 16-18 Years | -62 Kg

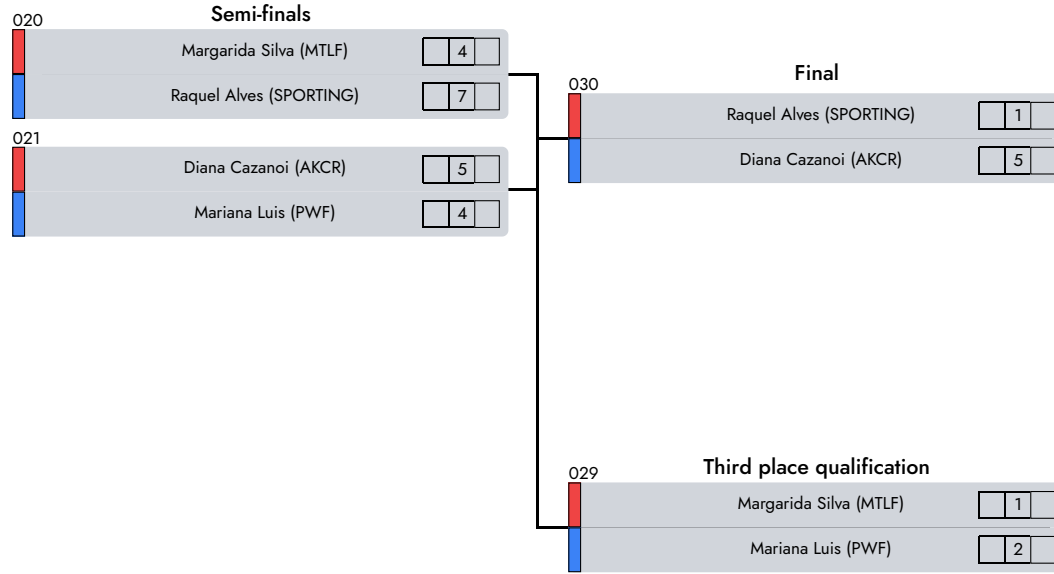

D1 - A3 - Morning

1° Diana Cazanoi (AKCR)

2° Raquel Alves (SPORTING)

3° Mariana Luis (PWF)

Note
NoneAREA: None

Judge 1

Central Referee

Judge 2

C. Nacional de Juvenis Juniores e Seniores

Semi Kempo | Masculine | 16-18 Years | -73 Kg

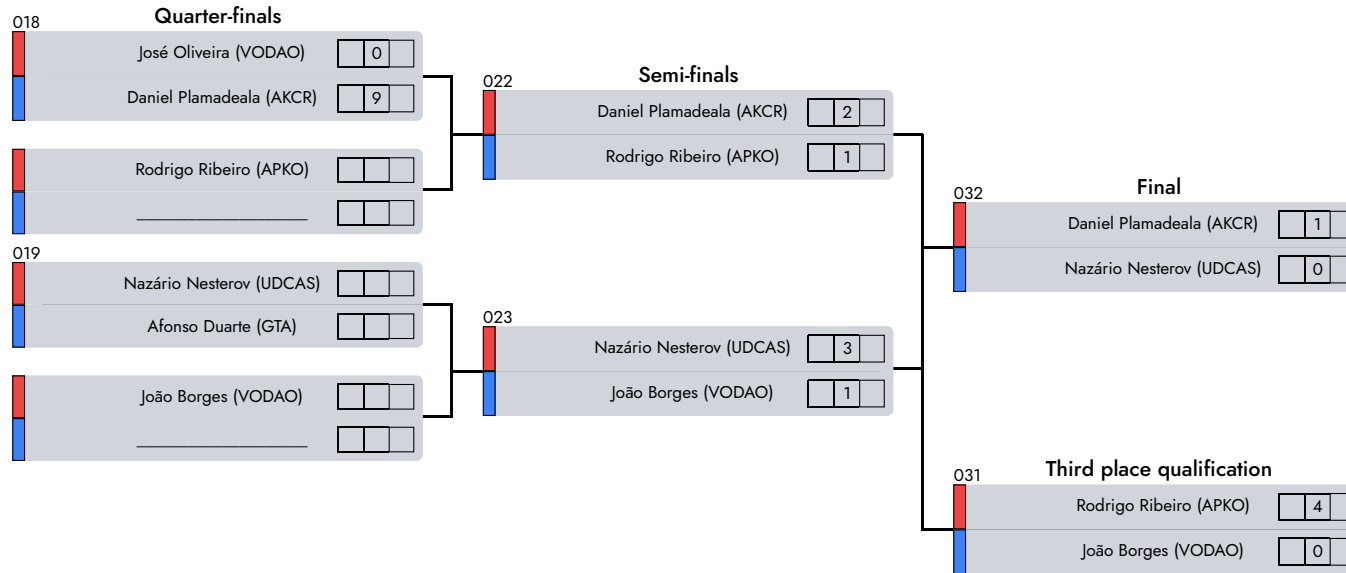

- D1 - A3 - Morning**
- 1° Daniel Plamadeala (AKCR)
 - 2° Nazário Nesterov (UDCAS)
 - 3° Rodrigo Ribeiro (APKO)
- Note
NoneAREA: None

Judge 1

Central Referee

Judge 2

C. Nacional de Juvenis Juniores e Seniores Semi Kempo | Feminine | 16-18 Years | -47 Kg

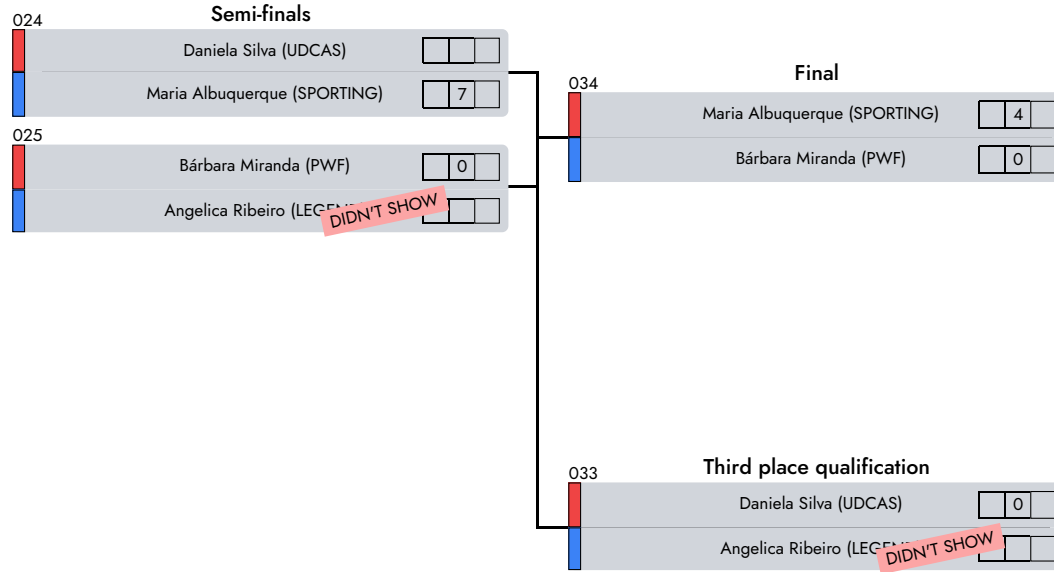

D1 - A3 - Morning

1° Maria Albuquerque (SPORTING)

2° Bárbara Miranda (PWF)

3° Daniela Silva (UDCAS)

Note
NoneAREA: None

Judge 1

Central Referee

Judge 2

C. Nacional de Juvenis Juniores e Seniores

Semi Kempo | Masculine | 16-18 Years | -53 Kg

Final	
026	Leonardo Lacatus (NINPO) <input type="text" value="2"/>
	Mohamed Sariane (CEFIDEC) <input type="text" value="1"/>
027	Leonardo Lacatus (NINPO) <input type="text" value="8"/>
	Simão Galvão (UDCAS) <input type="text" value="0"/>
028	Mohamed Sariane (CEFIDEC) <input type="text" value="4"/>
	Simão Galvão (UDCAS) <input type="text" value="0"/>

D1 - A3 - Morning

1° Leonardo Lacatus (NINPO)

2° Mohamed Sariane (CEFIDEC)

3° Simão Galvão (UDCAS)

Note

NoneAREA: None

Judge 1

Central Referee

Judge 2

C. Nacional de Juvenis Juniores e Seniores Semi Kempo | Masculine | 16-18 Years | -48 Kg

035

Final

Guilherme Rocha (UDCAS)

	5	
--	---	--

Rafael Lima (AKCM)

	1	
--	---	--

D1 - A3 - Morning

1° Guilherme Rocha (UDCAS)

2° Rafael Lima (AKCM)

Note

NoneAREA: None

AREA: None

Daniela Santos

Judge 1

Diogo Henriques

Central Referee

Marta Governo

Judge 2

C. Nacional de Juvenis Juniores e Seniores

Semi Kempo | Feminine | 16-18 Years | -57 Kg

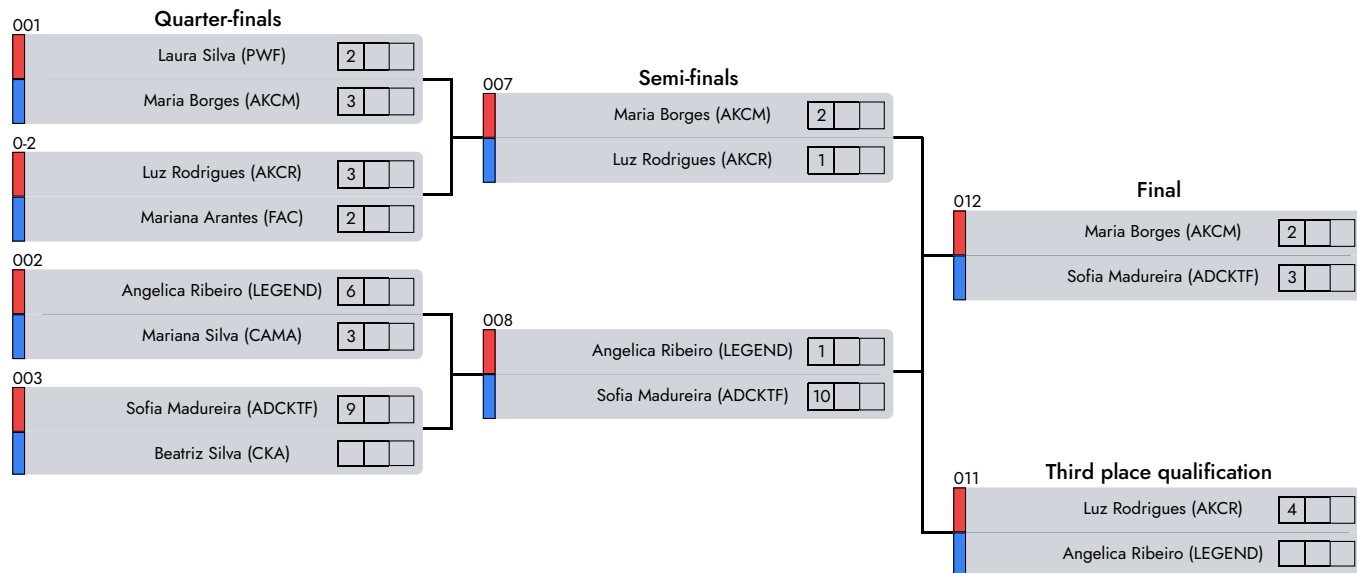

- 1° Sofia Madureira (ADCKTF)
 - 2° Maria Borges (AKCM)
 - 3° Luz Rodrigues (AKCR)
- Note
NoneAREA: None

Judge 1

Central Referee

Judge 2

C. Nacional de Juvenis Juniores e Seniores

Semi Kempo | Masculine | 16-18 Years | -68 Kg

D1 - A4 - Morning

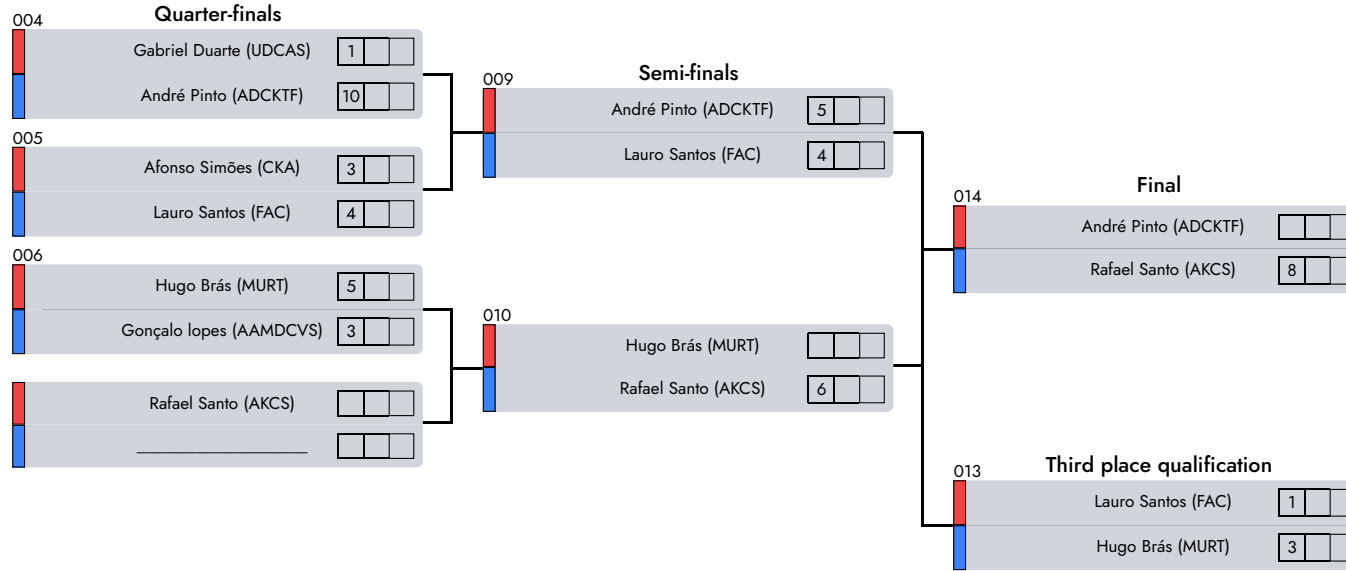

1° Rafael Santo (AKCS)

2° André Pinto (ADCKTF)

3° Hugo Brás (MURT)

Note
NoneAREA: None

Judge 1

Central Referee

Judge 2

C. Nacional de Juvenis Juniores e Seniores Semi Kempo | Feminine | 16-18 Years | -67 Kg

015

Final

Diana Portela (AKCR)

7

Rania Oliveira (PREDATOR)

1

D1 - A4 - Morning

1°

Diana Portela (AKCR)

2°

Rania Oliveira (PREDATOR)

Note

NoneAREA: None

AREA: None

Judge 1

Central Referee

Judge 2

C. Nacional de Juvenis Juniores e Seniores Semi Kempo | Masculine | 16-18 Years | -88 Kg

Final	
011	
	
Tiago Silva (CKA)	2
António Albuquerque (SPORTING)	3
012	
	
Tiago Silva (CKA)	4
Bruno D'Souza (CEFIDEC)	3
013	
	
António Albuquerque (SPORTING)	7
Bruno D'Souza (CEFIDEC)	5

D1 - A5 - Morning

1° António Albuquerque (SPORTING)

2° Tiago Silva (CKA)

3° Bruno D'Souza (CEFIDEC)

Note

NoneAREA: None

AREA: None

Judge 1

Central Referee

Judge 2

C. Nacional de Juvenis Juniores e Seniores

Semi Kempo | Masculine | 16-18 Years | -78 Kg

D1 - A5 - Morning

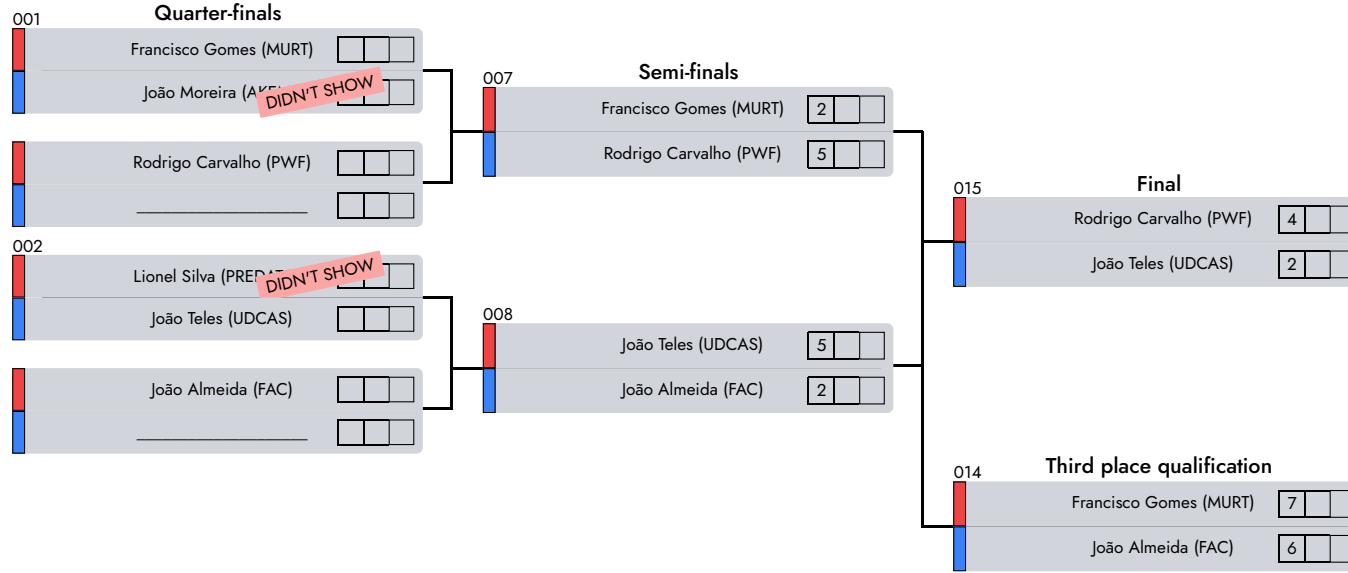

1° Rodrigo Carvalho (PWF)

2° João Teles (UDCAS)

3° Francisco Gomes (MURT)

Note
NoneAREA: None
AREA: None
AREA: None

Judge 1

Central Referee

Judge 2

C. Nacional de Juvenis Juniores e Seniores

Semi Kempo | Masculine | 16-18 Years | -58 Kg

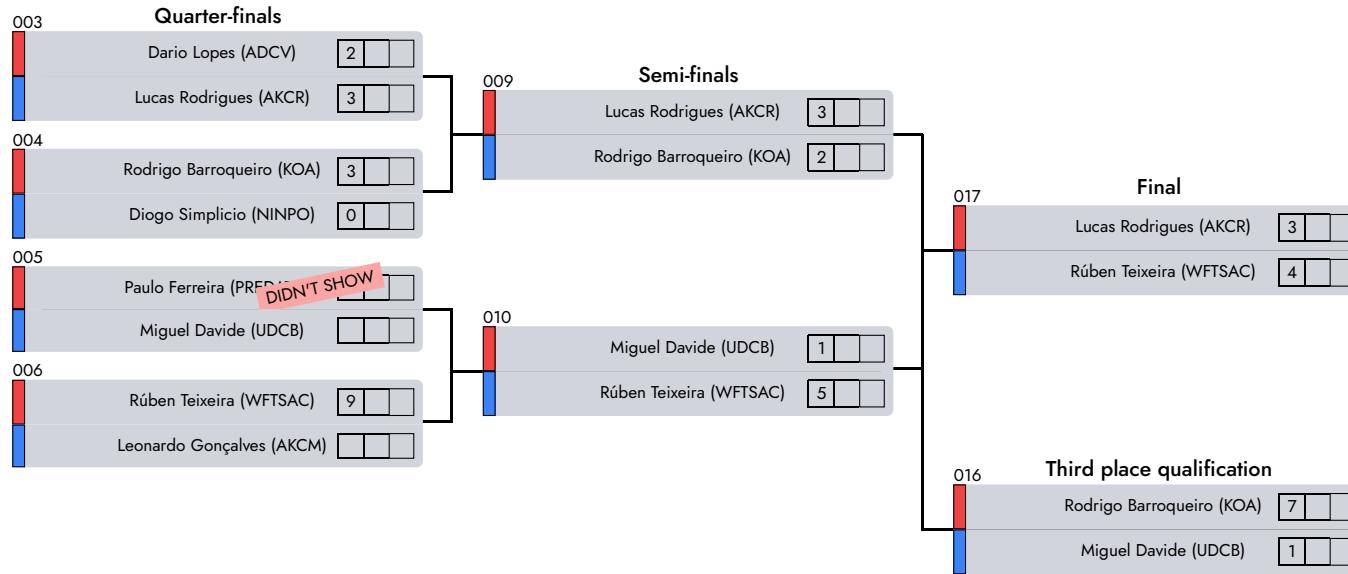

D1 - A5 - Morning

1° Rúben Teixeira (WFTSAC)

2° Lucas Rodrigues (AKCR)

3° Rodrigo Barroqueiro (KOA)

Note
NoneAREA: None
AREA: None
AREA: None
AREA: None

Judge 1

Central Referee

Judge 2

C. Nacional de Juvenis Juniores e Seniores

Semi Kempo | Masculine | 16-18 Years | -63 Kg

D1 - A6 - Morning

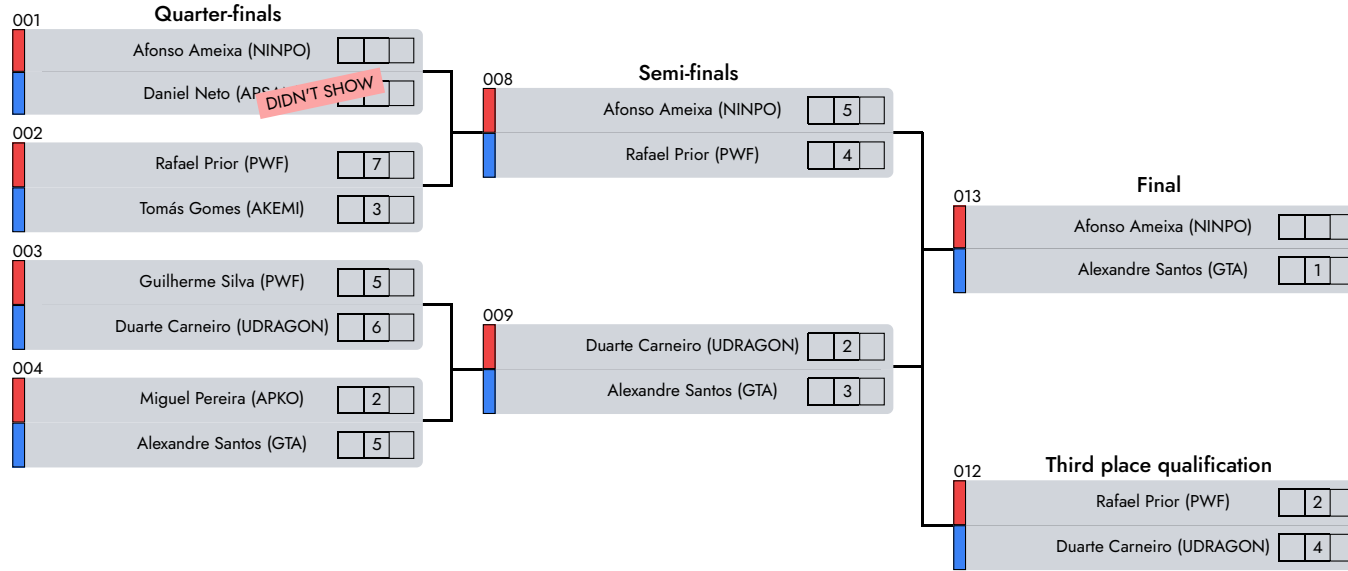

1° Alexandre Santos (GTA)

2° Afonso Ameixa (NINPO)

3° Duarte Carneiro (UDRAGON)

Note
NoneAREA: None
AREA: None

Daniela Santos
Judge 1

Diogo Henriques
Central Referee

Marta Governo
Judge 2

C. Nacional de Juvenis Juniores e Seniores Semi Kempo | Feminine | 16-18 Years | -52 Kg

016

Final

Matilde Freitas (WOLVES)

--	--	--

Bárbara Rações (AKKL)

DIDN'T SHOW

--	--	--

D1 - A6 - Morning

1°

Matilde Freitas (WOLVES)

2°

Bárbara Rações (AKKL)

Note

NoneAREA: None

AREA: None

Daniela Santos

Judge 1

Diogo Henriques

Central Referee

Marta Governo

Judge 2

C. Nacional de Juvenis Juniores e Seniores

Semi Kempo | Feminine | 16-18 Years | +72 Kg

D1 - A6 - Morning

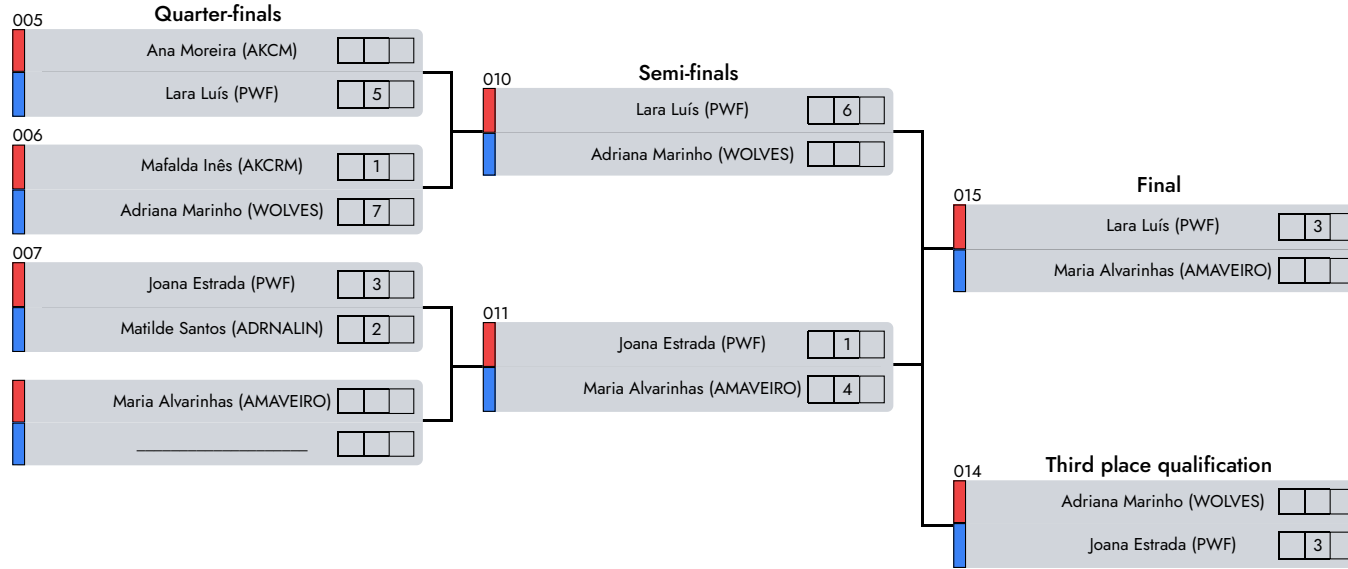

1° Lara Luís (PWF)

2° Maria Alvarinhas (AMAVEIRO)

3° Joana Estrada (PWF)

Note
NoneAREA: None
AREA: None

Daniela Santos
Judge 1

Diogo Henriques
Central Referee

Marta Governo
Judge 2

C. Nacional de Juvenis Juniores e Seniores

Formas Mão Vazia | Masculine | 16-17 Years

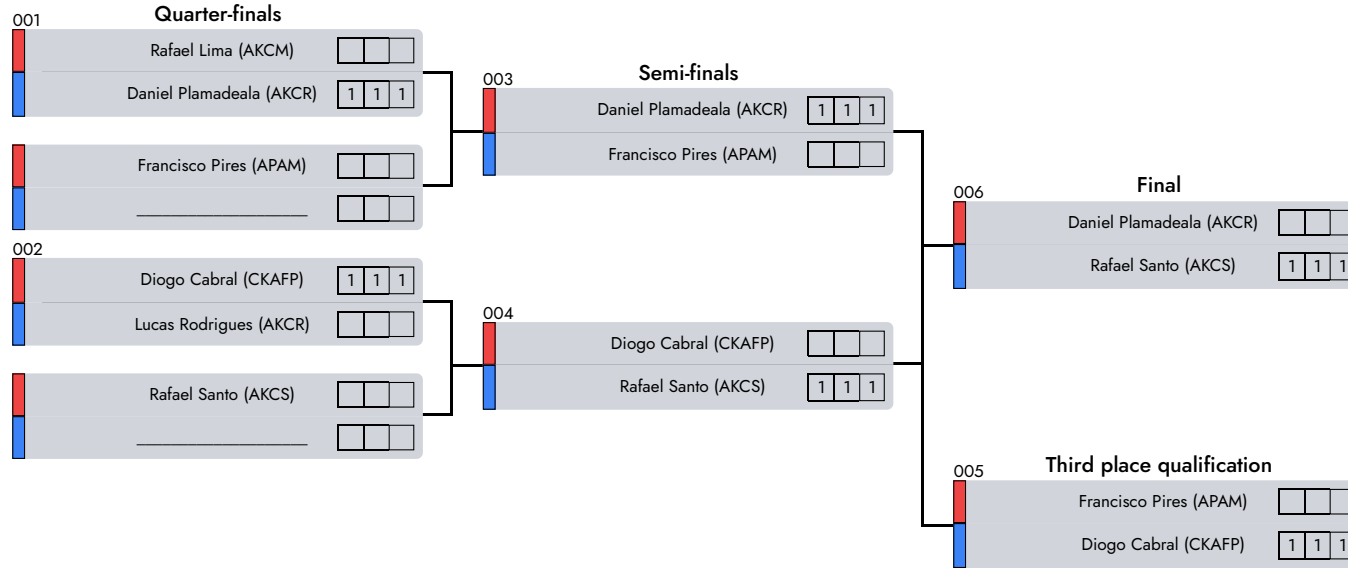

D1 - A1 - Afternoon

1° Rafael Santo (AKCS)

2° Daniel Plamadeala (AKCR)

3° Diogo Cabral (CKAFP)

Note
NoneAREA: None

Judge 1

Central Referee

Judge 2

C. Nacional de Juvenis Juniores e Seniores

Formas Mão Vazia | Masculine | 30-39 Years

Final

007	Tiago Soares (AMAVEIRO)	<input type="text" value="1"/>
	Pedro Rodrigues (CEFIDEC)	<input type="text" value="1"/> <input type="text" value="1"/>
008	Tiago Soares (AMAVEIRO)	<input type="text" value="1"/> <input type="text" value="1"/> <input type="text" value="1"/>
	Eduardo Silva (PWF)	<input type="text" value=""/> <input type="text" value=""/> <input type="text" value=""/>
009	Pedro Rodrigues (CEFIDEC)	<input type="text" value="1"/> <input type="text" value="1"/> <input type="text" value="1"/>
	Eduardo Silva (PWF)	<input type="text" value=""/> <input type="text" value=""/> <input type="text" value=""/>

D1 - A1 - Afternoon

1° Pedro Rodrigues (CEFIDEC)

2° Tiago Soares (AMAVEIRO)

3° Eduardo Silva (PWF)

Note

NoneAREA: None

Judge 1

Central Referee

Judge 2

C. Nacional de Juvenis Juniores e Seniores

Formas Mão Vazia | Masculine | 40-65 Years

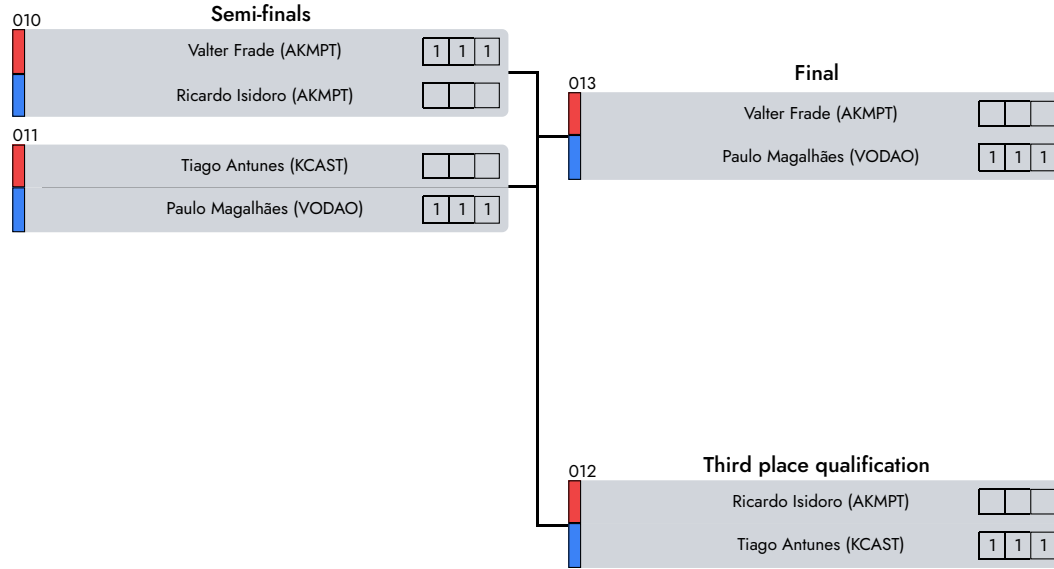

D1 - A1 - Afternoon

1° Paulo Magalhães (VODAO)

2° Valter Frade (AKMPT)

3° Tiago Antunes (KCAST)

Note
NoneAREA: None

Judge 1

Central Referee

Judge 2

C. Nacional de Juvenis Juniores e Seniores

Formas Mão Vazia | Feminine | 16-17 Years

D1 - A1 - Afternoon

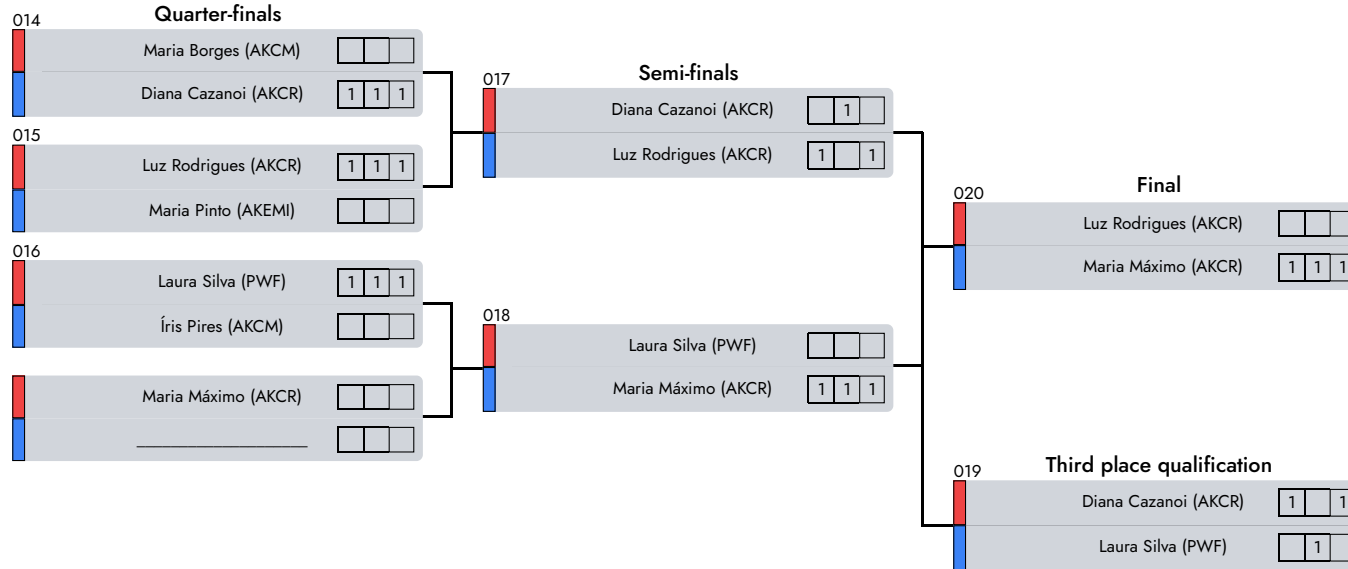

1° Maria Máximo (AKCR)

2° Luz Rodrigues (AKCR)

3° Diana Cazanoi (AKCR)

Note
NoneAREA: None

Judge 1

Central Referee

Judge 2

C. Nacional de Juvenis Juniores e Seniores

Formas Mão Vazia | Feminine | 40-65 Years

021

Final

Ana Assis (AKCS)

--	--	--

--	--	--

D1 - A1 - Afternoon

1°

Ana Assis (AKCS)

Note

No notes

Judge 1

Central Referee

Judge 2

C. Nacional de Juvenis Juniores e Seniores

Formas c/ Armas | Masculine | 16-17 Years

D1 - A1 - Afternoon

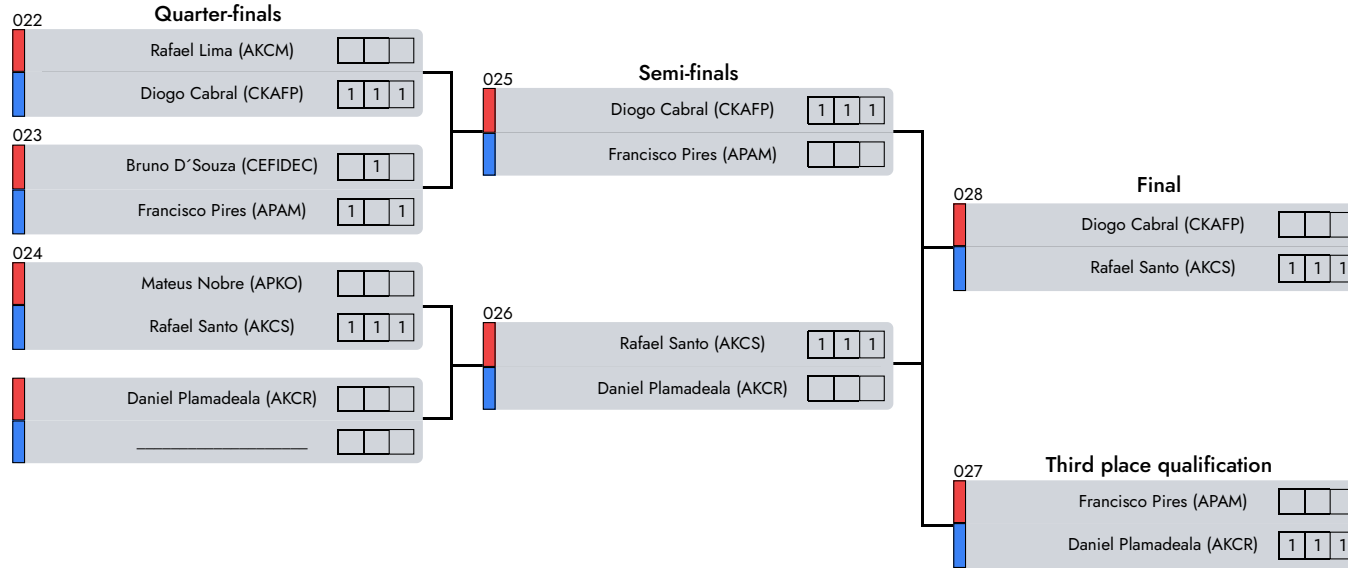

1° Rafael Santo (AKCS)

2° Diogo Cabral (CKAFP)

3° Daniel Plamadeala (AKCR)

Note
NoneAREA: None

Judge 1

Central Referee

Judge 2

C. Nacional de Juvenis Juniores e Seniores

Formas c/ Armas | Masculine | 30-39 Years

Final

029	Eduardo Silva (PWF)	<input type="checkbox"/>	<input type="checkbox"/>	<input type="checkbox"/>
	Pedro Rodrigues (CEFIDEC)	<input type="checkbox"/>	<input type="checkbox"/>	<input type="checkbox"/>
030	Eduardo Silva (PWF)	<input type="checkbox"/>	<input type="checkbox"/>	<input type="checkbox"/>
	Tiago Soares (AMAVEIRO)	<input type="checkbox"/>	<input type="checkbox"/>	<input type="checkbox"/>
031	Pedro Rodrigues (CEFIDEC)	<input type="checkbox"/>	<input type="checkbox"/>	<input type="checkbox"/>
	Tiago Soares (AMAVEIRO)	<input type="checkbox"/>	<input type="checkbox"/>	<input type="checkbox"/>

D1 - A1 - Afternoon

1° Tiago Soares (AMAVEIRO)

2° Pedro Rodrigues (CEFIDEC)

3° Eduardo Silva (PWF)

Note

NoneAREA: None

Judge 1

Central Referee

Judge 2

C. Nacional de Juvenis Juniores e Seniores

Formas c/ Armas | Masculine | 40-65 Years

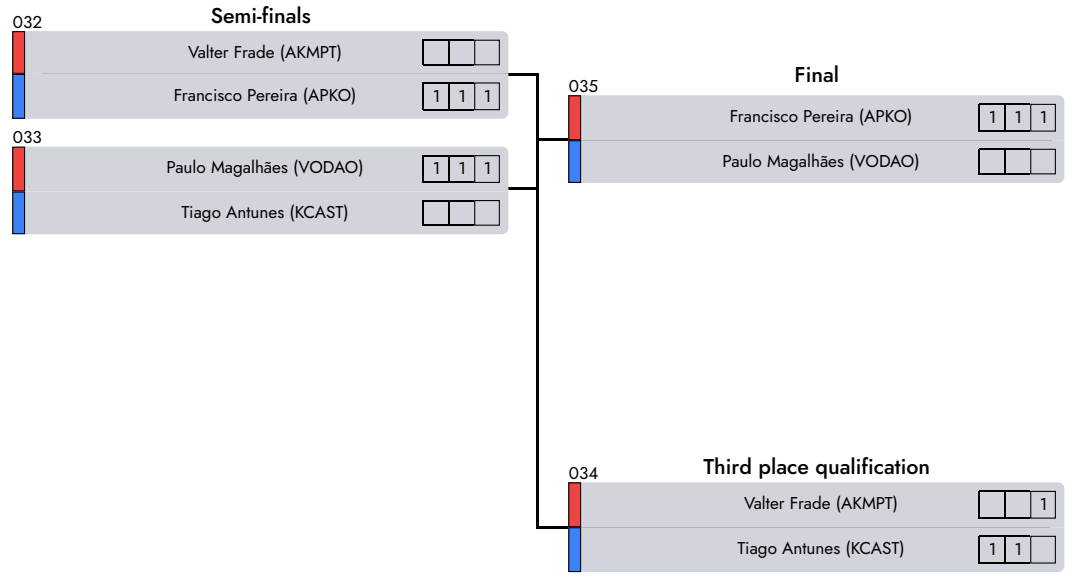

D1 - A1 - Afternoon

1° Francisco Pereira (APKO)

2° Paulo Magalhães (VODAO)

3° Tiago Antunes (KCAST)

Note
 NoneAREA: None

Judge 1

Central Referee

Judge 2

C. Nacional de Juvenis Juniores e Seniores

Formas c/ Armas | Feminine | 16-17 Years

D1 - A1 - Afternoon

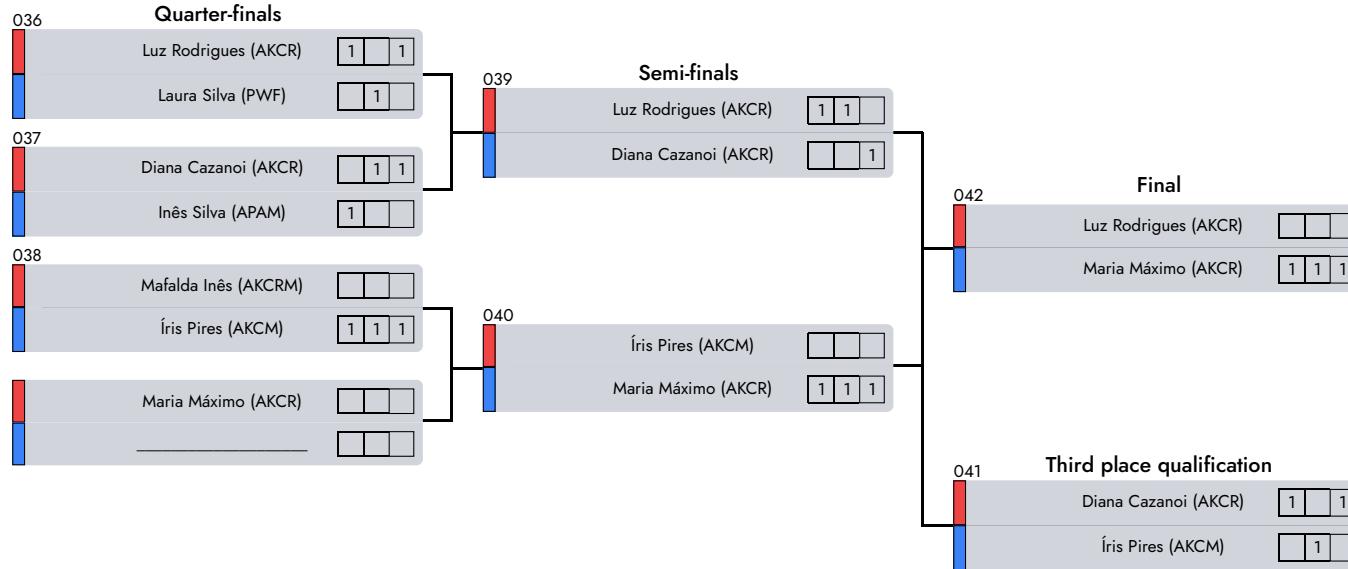

- 1° Maria Máximo (AKCR)
 - 2° Luz Rodrigues (AKCR)
 - 3° Diana Cazanoi (AKCR)
- Note
 NoneAREA: None

Judge 1

Central Referee

Judge 2

C. Nacional de Juvenis Juniores e Seniores

Formas c/ Armas | Feminine | 30-39 Years

Final		
043	Solange Lavos (PWF)	1 1
	Marta Coelho (ADKT)	1 1
044	Solange Lavos (PWF)	1 1 1
	Vânia Ribeiro (APKO)	1 1 1
045	Marta Coelho (ADKT)	1 1 1
	Vânia Ribeiro (APKO)	1 1 1

D1 - A1 - Afternoon

1°	Vânia Ribeiro (APKO)
2°	Solange Lavos (PWF)
3°	Marta Coelho (ADKT)
Note NoneAREA: None	

Judge 1

Central Referee

Judge 2

C. Nacional de Juvenis Juniores e Seniores Formas c/ Armas | Feminine | 40-65 Years

046

Final

Marina Cardona (CAMCTO)

1	1	
---	---	--

Sara Lopes (ADKT)

		1
--	--	---

D1 - A1 - Afternoon

1° Marina Cardona (CAMCTO)

2° Sara Lopes (ADKT)

Note

NoneAREA: None

Judge 1

Central Referee

Judge 2

C. Nacional de Juvenis Juniores e Seniores

Semi Kempo | Masculine | 14-15 Years | -58 Kg

D1 - A2 - Afternoon

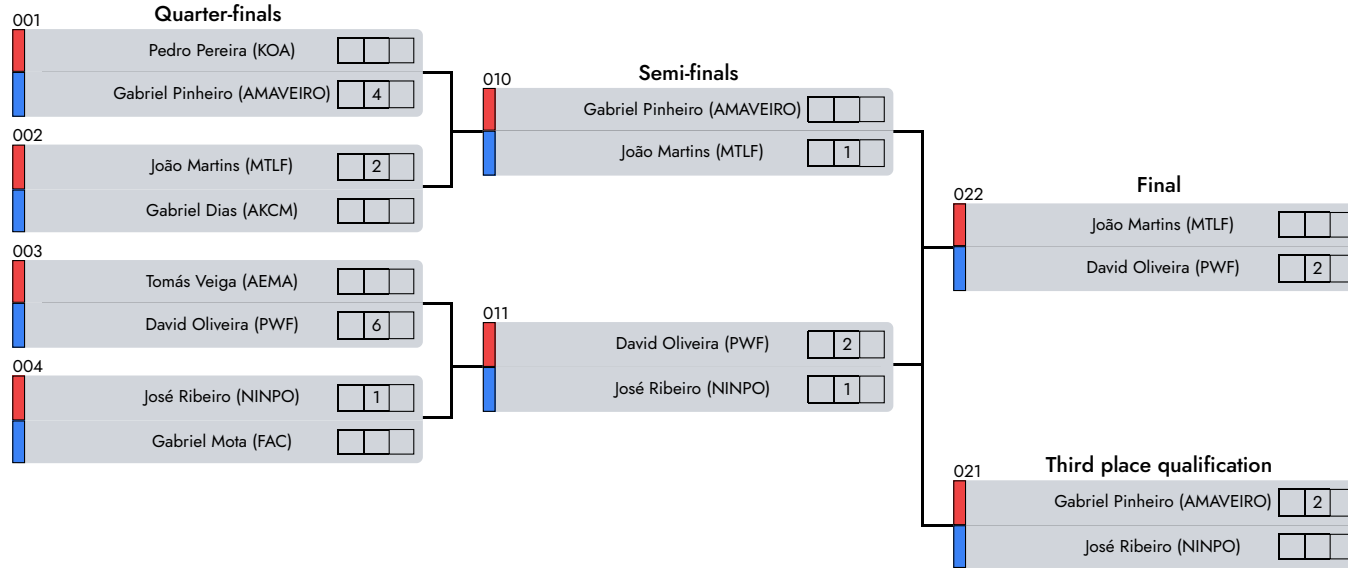

1° David Oliveira (PWF)

2° João Martins (MTLF)

3° Gabriel Pinheiro (AMAVEIRO)

Note
NoneAREA: None

Judge 1

Central Referee

Judge 2

C. Nacional de Juvenis Juniores e Seniores Semi Kempo | Masculine | 14-15 Years | -48 Kg

Final					
018	Emanuel Taborda (CAMCTO)	<input type="text"/>	<input type="text"/>	<input type="text"/>	
	Jaime Cordeiro (CPKP)	DIDN'T SHOW		<input type="text"/>	<input type="text"/>
019	Emanuel Taborda (CAMCTO)	<input type="text"/>	<input type="text"/>	<input type="text"/>	
	Paulo Nazaruk (NINPO)	<input type="text"/>	3	<input type="text"/>	
020	Jaime Cordeiro (CPKP)	DIDN'T SHOW		<input type="text"/>	<input type="text"/>
	Paulo Nazaruk (NINPO)	<input type="text"/>	<input type="text"/>	<input type="text"/>	

D1 - A2 - Afternoon

1° Paulo Nazaruk (NINPO)

2° Emanuel Taborda (CAMCTO)

3° _____

Note

NoneAREA: None

Judge 1

Central Referee

Judge 2

C. Nacional de Juvenis Juniores e Seniores

Semi Kempo | Masculine | 19-40 Years | -78 Kg

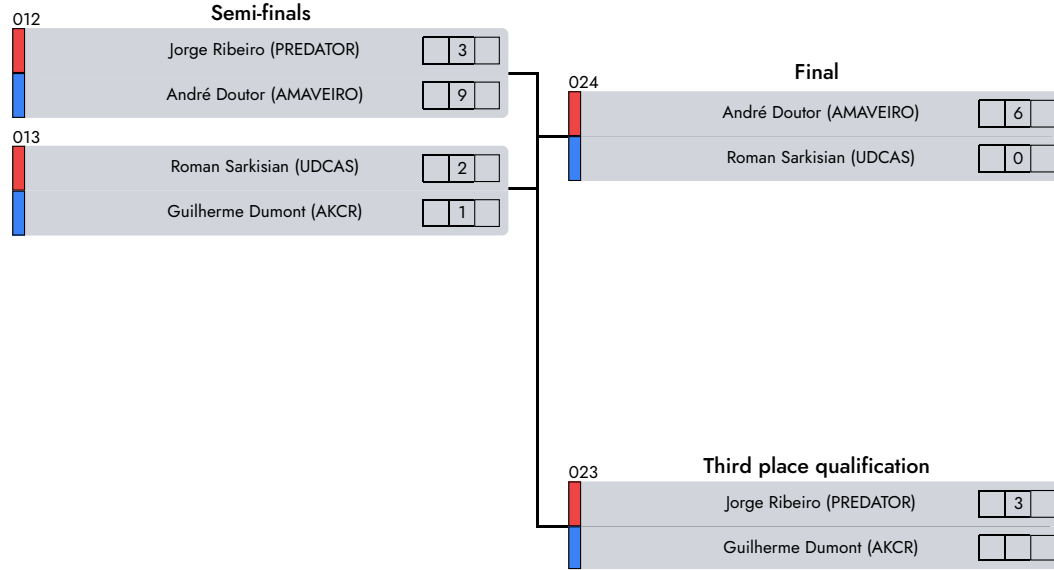

1° André Doutor (AMAVEIRO)

2° Roman Sarkisian (UDCAS)

3° Jorge Ribeiro (PREDATOR)

Note
NoneAREA: None
AREA: None

D1 - A2 - Afternoon

Judge 1

Central Referee

Judge 2

C. Nacional de Juvenis Juniores e Seniores

Semi Kempo | Masculine | 19-40 Years | -68 Kg

D1 - A2 - Afternoon

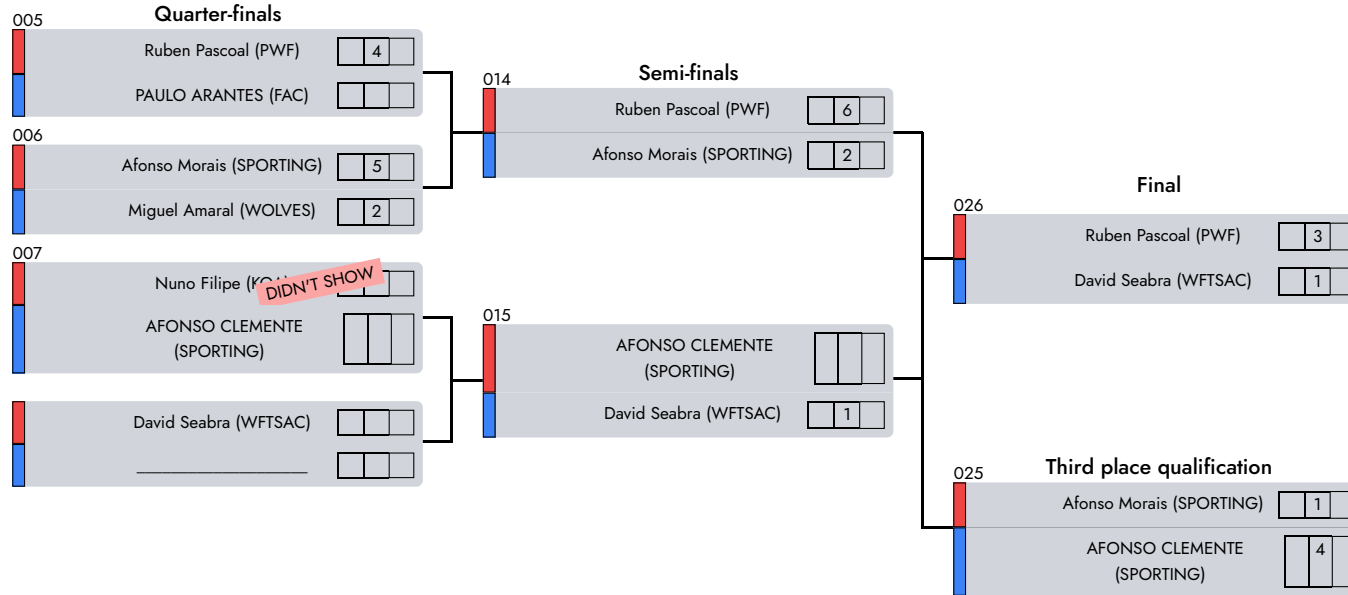

1° Ruben Pascoal (PWF)

2° David Seabra (WFTSAC)

3° AFONSO CLEMENTE (SPORTING)

Note
NoneAREA: None
AREA: None

Daniela Santos
Judge 1

Diogo Henriques
Central Referee

Marta Governo
Judge 2

C. Nacional de Juvenis Juniores e Seniores

Semi Kempo | Masculine | 41-50 Years | -73 Kg

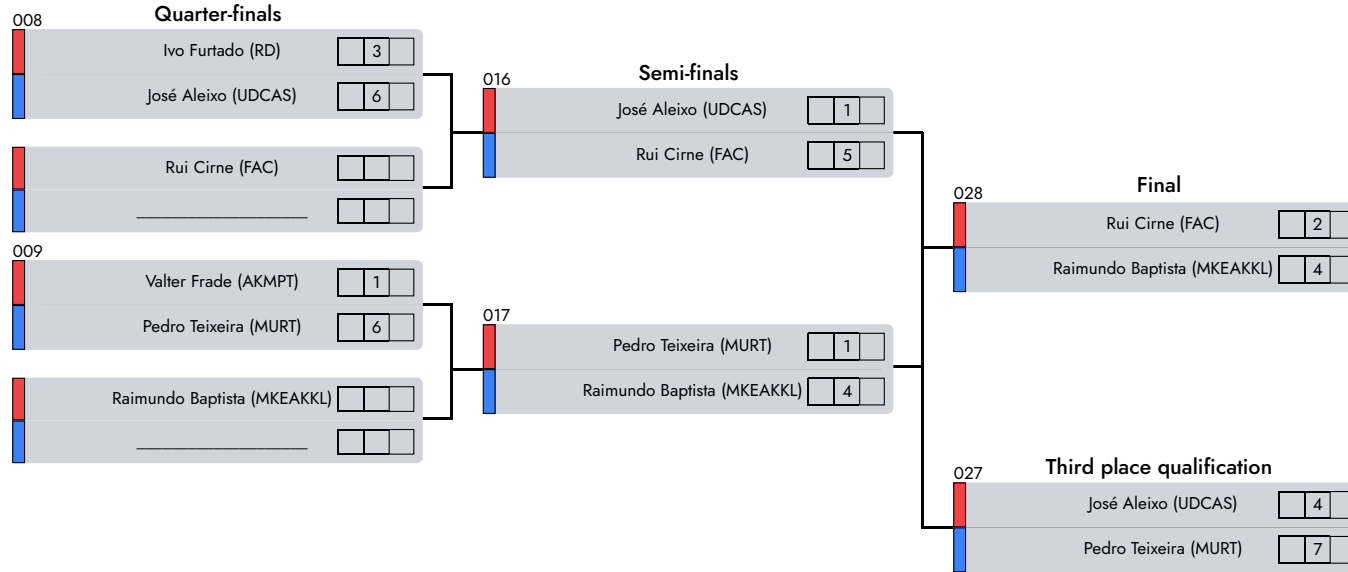

1° Raimundo Baptista (MKEAKKL)

2° Rui Cirne (FAC)

3° Pedro Teixeira (MURT)

Note
NoneAREA: None
AREA: None

Daniela Santos
Judge 1

Diogo Henriques
Central Referee

Marta Governo
Judge 2

C. Nacional de Juvenis Juniores e Seniores

Semi Kempo | Masculine | 14-15 Years | -43 Kg

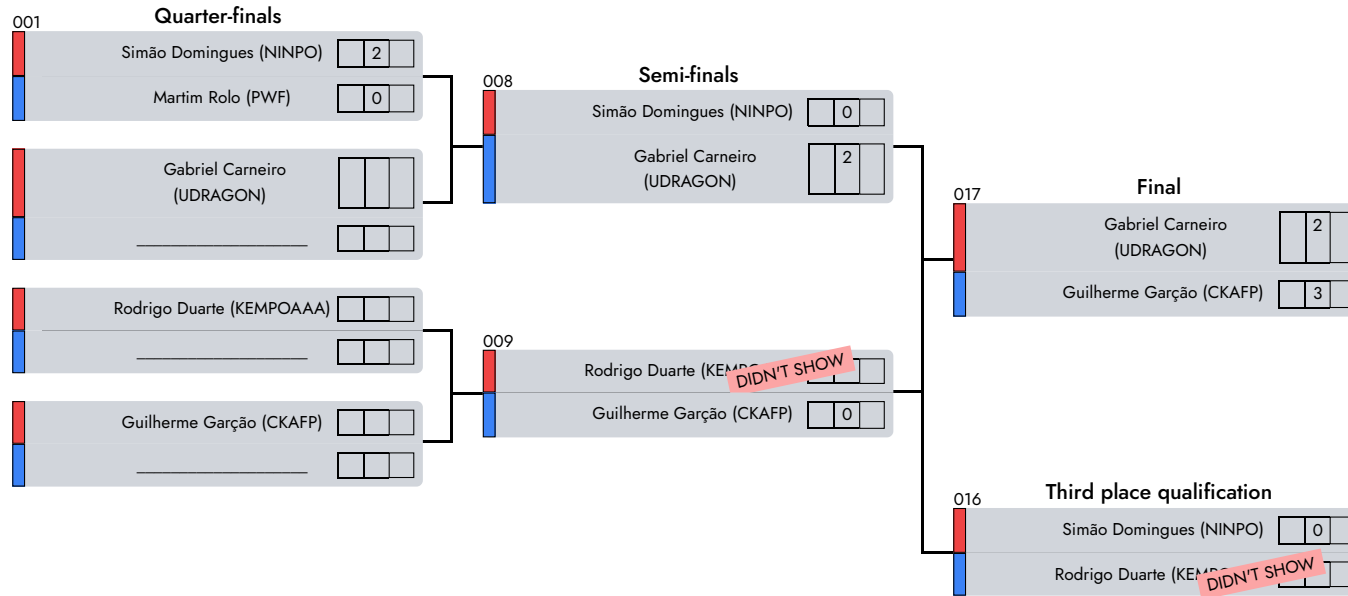

1° Guilherme Garção (CKAFP)

2° Gabriel Carneiro (UDRAGON)

3° Simão Domingues (NINPO)

Note
 NoneAREA: None

C. Nacional de Juvenis Juniores e Seniores

Semi Kempo | Feminine | 14-15 Years | +64 Kg

D1 - A3 - Afternoon

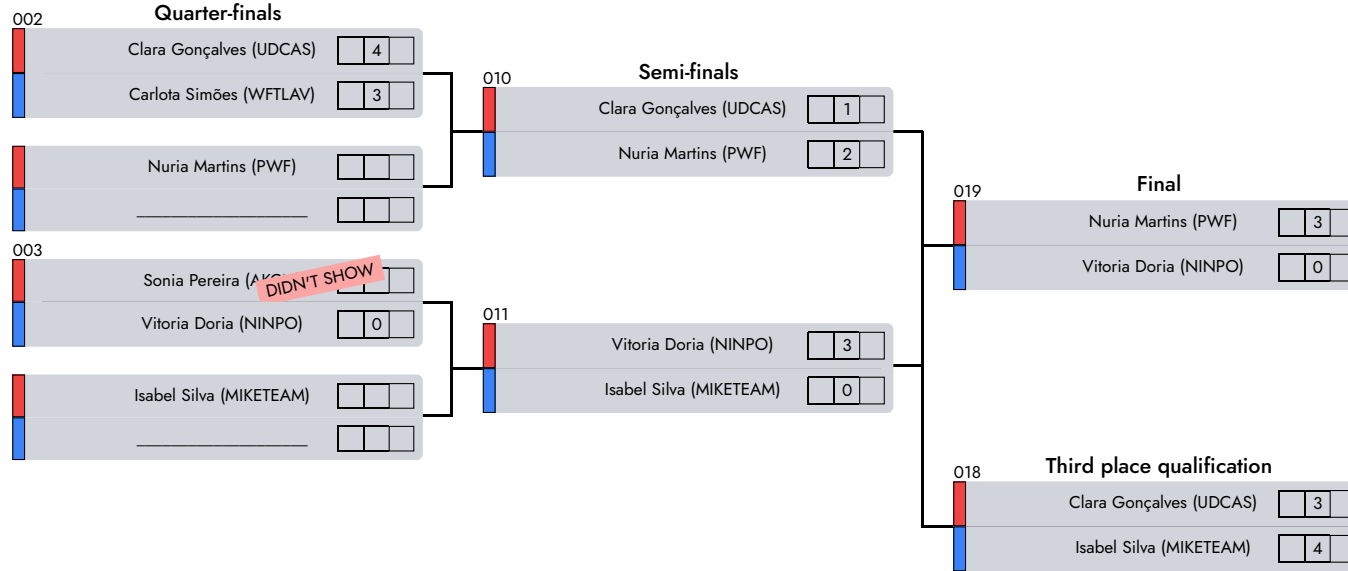

1° Nuria Martins (PWF)

2° Vitoria Doria (NINPO)

3° Isabel Silva (MIKETEAM)

Note
NoneAREA: None

Judge 1

Central Referee

Judge 2

C. Nacional de Juvenis Juniores e Seniores

Semi Kempo | Masculine | 14-15 Years | +73 Kg

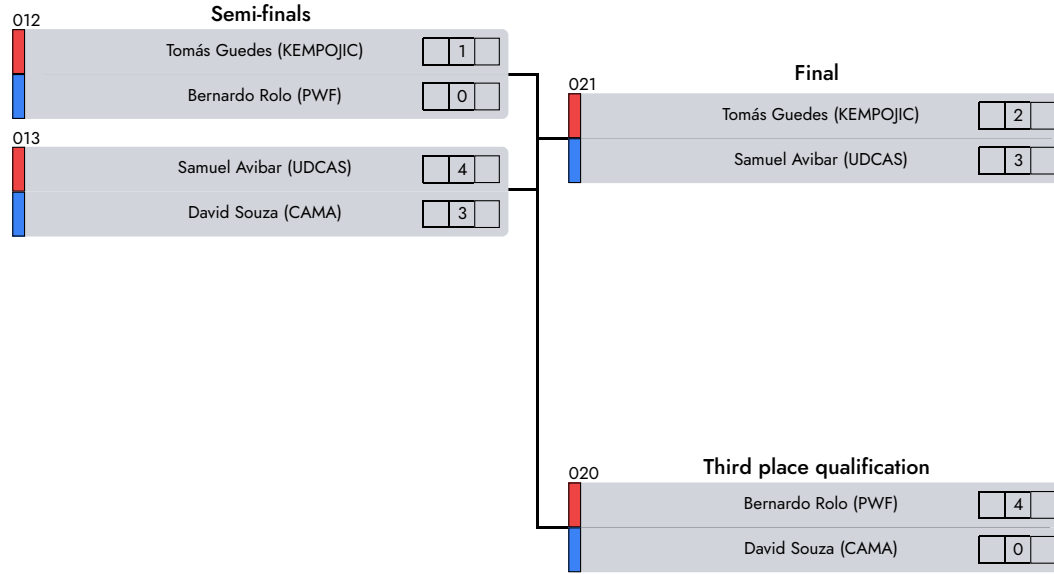

D1 - A3 - Afternoon

1° Samuel Avibar (UDCAS)

2° Tomás Guedes (KEMPOJIC)

3° Bernardo Rolo (PWF)

Note
NoneAREA: None

Judge 1

Central Referee

Judge 2

C. Nacional de Juvenis Juniores e Seniores

Semi Kempo | Masculine | 19-40 Years | -73 Kg

D1 - A3 - Afternoon

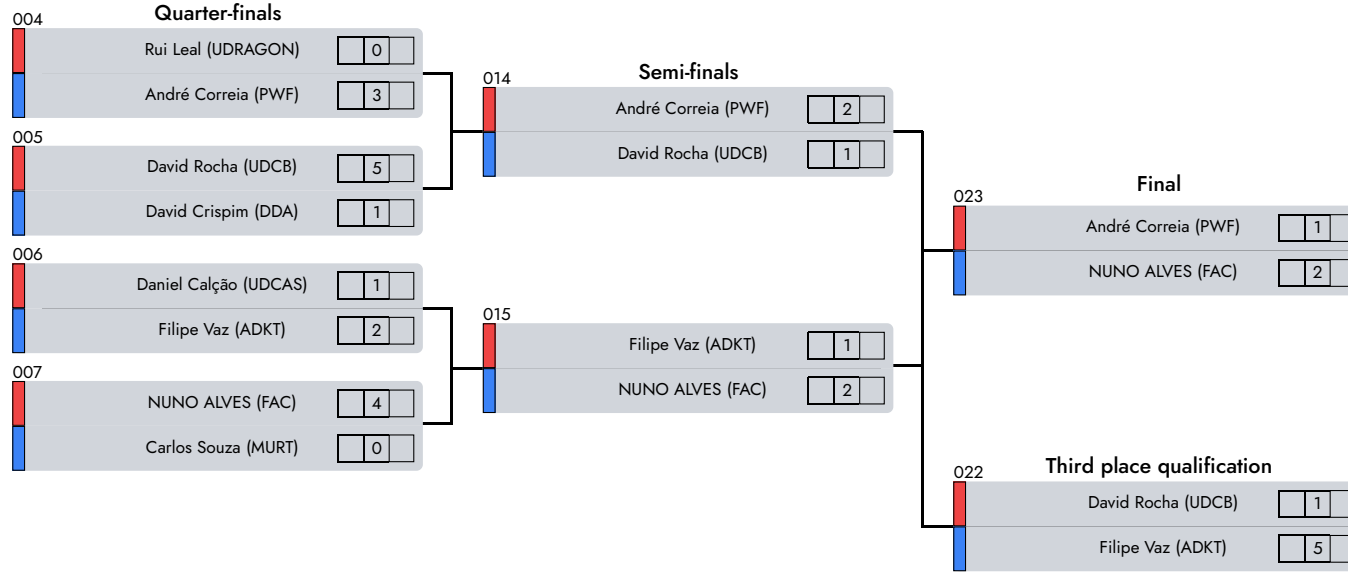

1° NUNO ALVES (FAC)

2° André Correia (PWF)

3° Filipe Vaz (ADKT)

Note
NoneAREA: None

Judge 1

Central Referee

Judge 2

C. Nacional de Juvenis Juniores e Seniores

Semi Kempo | Masculine | 14-15 Years | -68 Kg

D1 - A4 - Afternoon

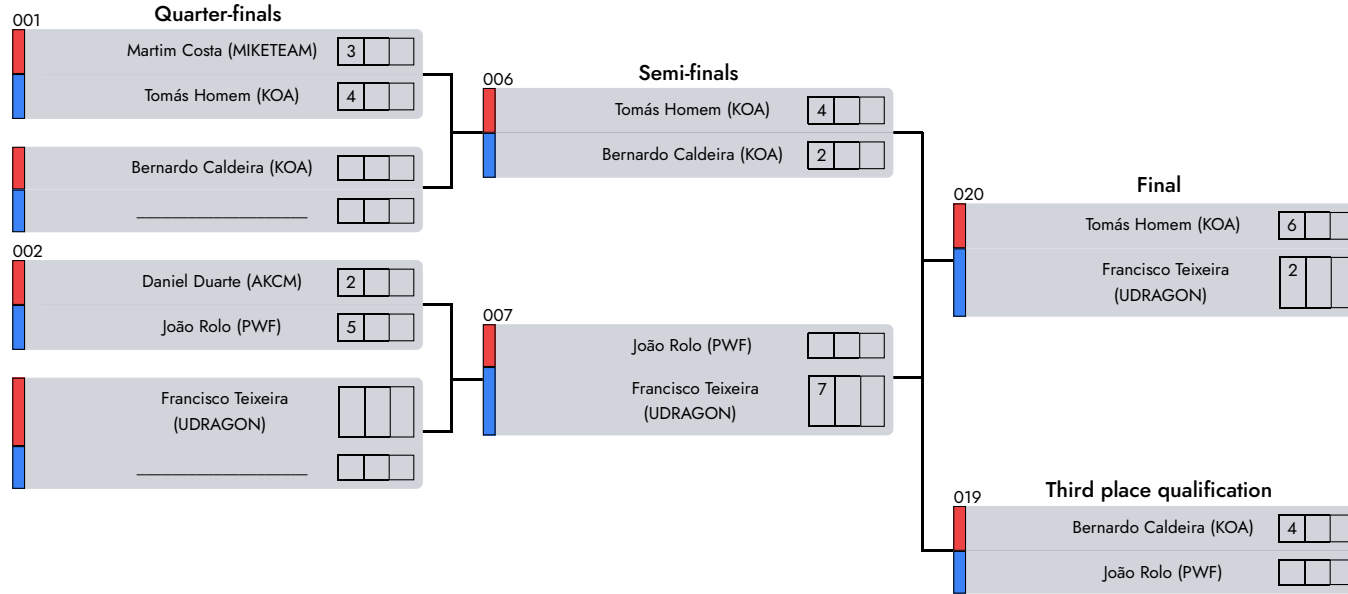

1° Tomás Homem (KOA)

2° Francisco Teixeira (UDRAGON)

3° Bernardo Caldeira (KOA)

Note
NoneAREA: None

Judge 1

Central Referee

Judge 2

C. Nacional de Juvenis Juniores e Seniores

Semi Kempo | Feminine | 14-15 Years | -59 Kg

D1 - A4 - Afternoon

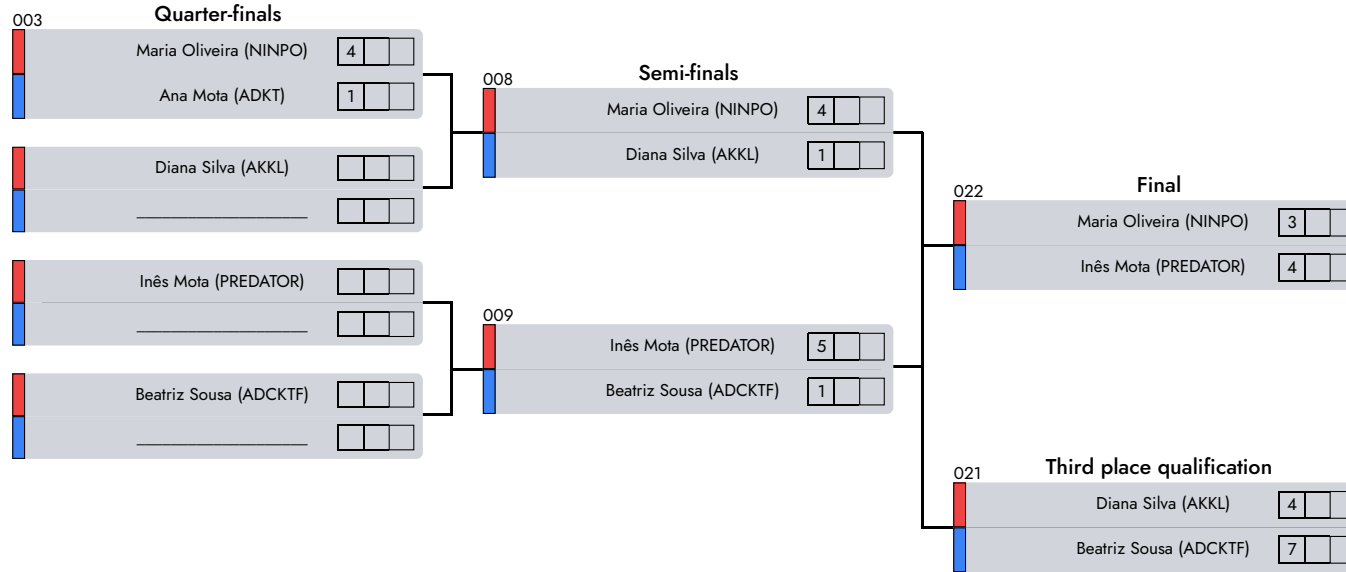

1° Inês Mota (PREDATOR)

2° Maria Oliveira (NINPO)

3° Beatriz Sousa (ADCKTF)

Note
NoneAREA: None

Judge 1

Central Referee

Judge 2

C. Nacional de Juvenis Juniores e Seniores

Semi Kempo | Masculine | 19-40 Years | -88 Kg

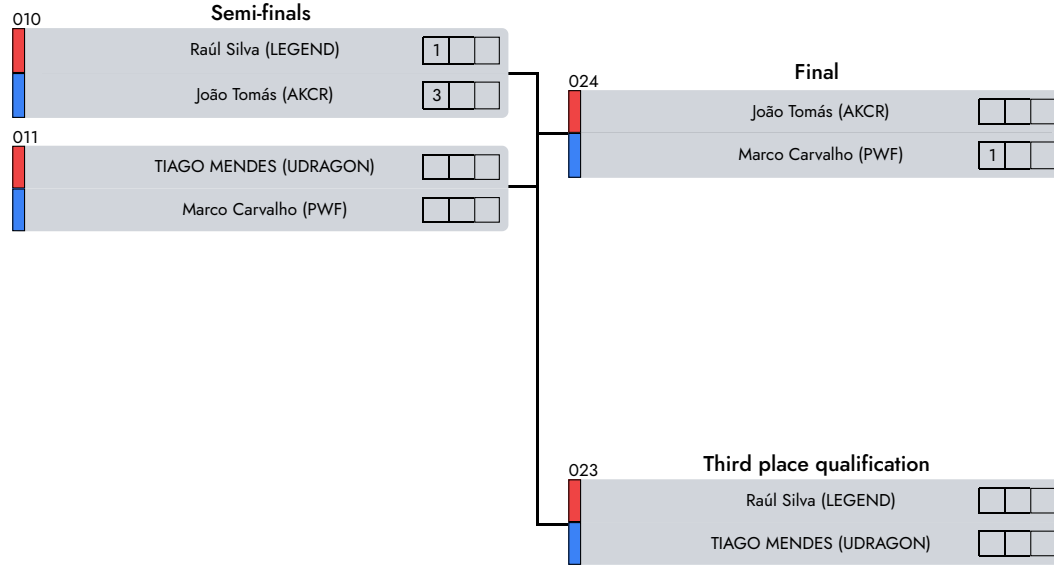

D1 - A4 - Afternoon

1° Marco Carvalho (PWF)

2° João Tomás (AKCR)

3° Raúl Silva (LEGEND)

Note
NoneAREA: None

Judge 1

Central Referee

Judge 2

C. Nacional de Juvenis Juniores e Seniores

Semi Kempo | Masculine | 19-40 Years | -83 Kg

D1 - A4 - Afternoon

016

Final

Saul Coelho (UDRAGON)

1

Andre Bondarenko (NINPO)

3

017

Saul Coelho (UDRAGON)

2

Daniel Santos (PWF)

1

018

Andre Bondarenko (NINPO)

Daniel Santos (PWF)

1°

2°

3°

Note

No notes

Judge 1

Central Referee

Judge 2

C. Nacional de Juvenis Juniores e Seniores

Semi Kempo | Masculine | 19-40 Years | -63 Kg

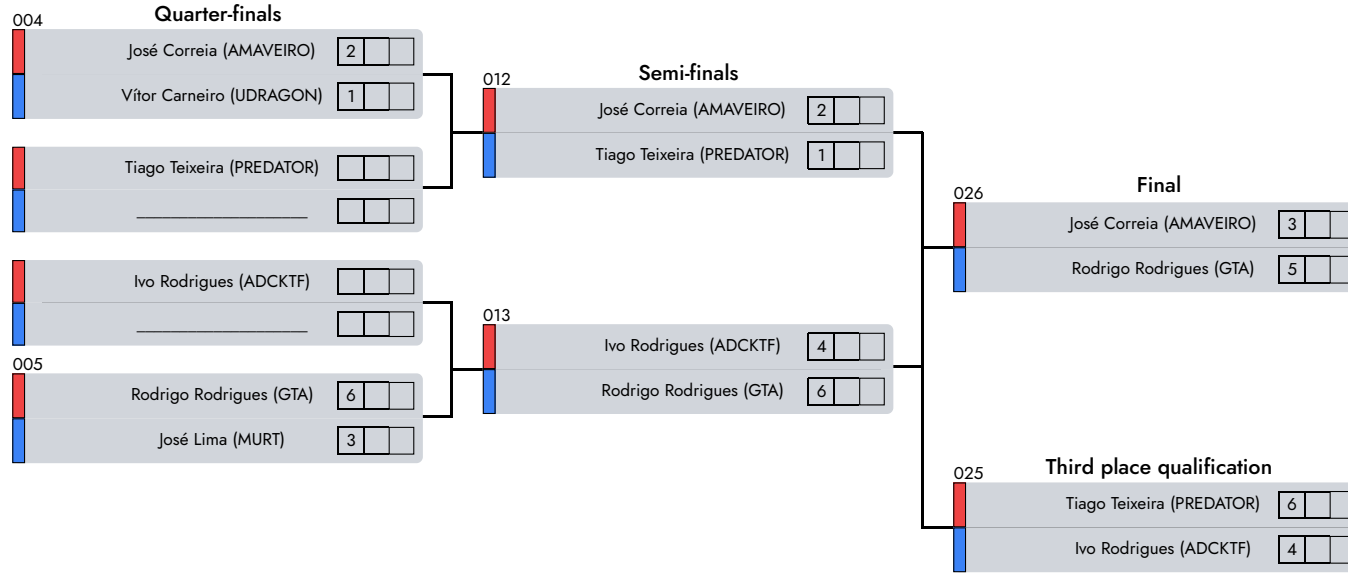

D1 - A4 - Afternoon

1° Rodrigo Rodrigues (GTA)

2° José Correia (AMAVEIRO)

3° Tiago Teixeira (PREDATOR)

Note
No notes

Judge 1

Central Referee

Judge 2

C. Nacional de Juvenis Juniores e Seniores

Semi Kempo | Masculine | 41-50 Years | +91 Kg

029

Final

Carlos Sampaio (PREDATOR)

--	--	--

Hugo Mendes (RD)

--	--	--

D1 - A4 - Afternoon

1°

2°

Note

No notes

Judge 1

Central Referee

Judge 2

C. Nacional de Juvenis Juniores e Seniores

Semi Kempo | Masculine | 51-65 Years | +10 Kg

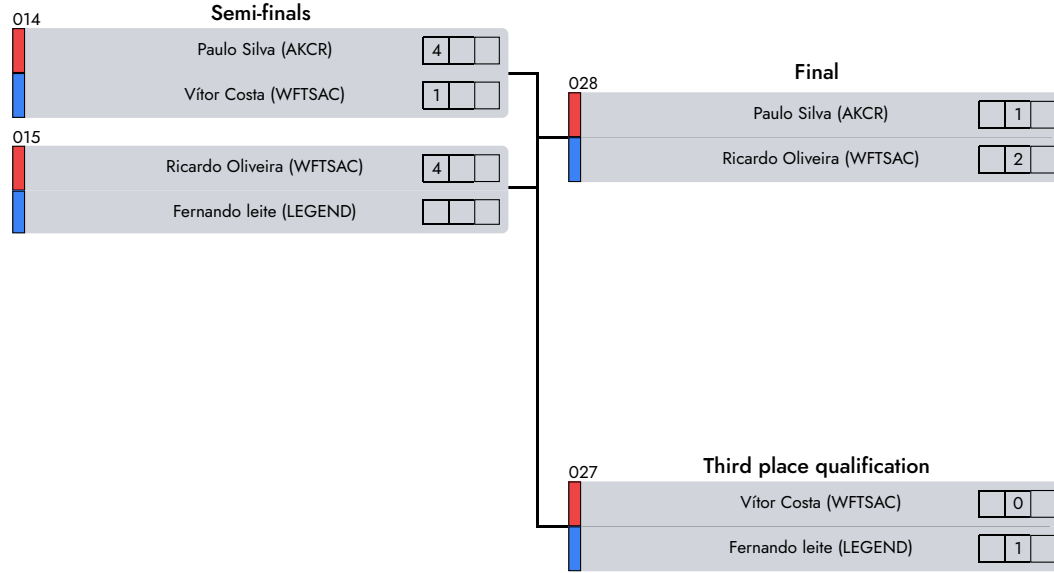

D1 - A4 - Afternoon

1° Ricardo Oliveira (WFTSAC)

2° Paulo Silva (AKCR)

3° Fernando leite (LEGEND)

Note
NoneAREA: None

Judge 1

Central Referee

Judge 2

C. Nacional de Juvenis Juniores e Seniores

Semi Kempo | Feminine | 14-15 Years | -49 Kg

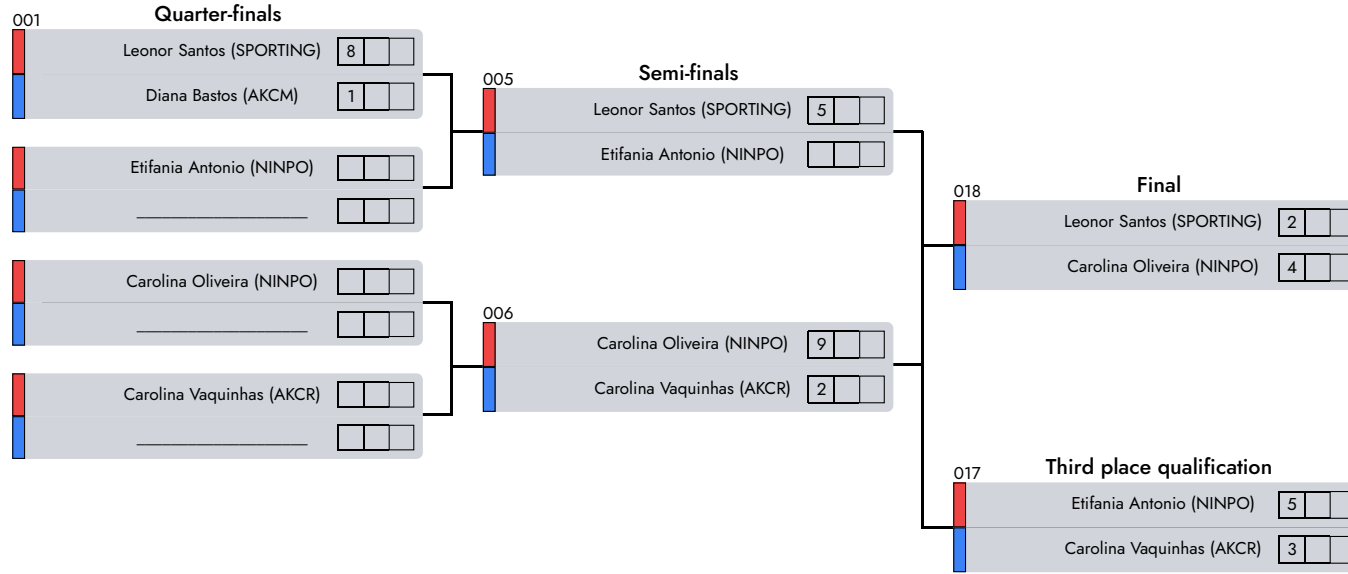

1° Carolina Oliveira (NINPO)

2° Leonor Santos (SPORTING)

3° Etifania Antonio (NINPO)

Note
NoneAREA: None

Judge 1

Central Referee

Judge 2

C. Nacional de Juvenis Juniores e Seniores Semi Kempo | Feminine | 14-15 Years | -64 Kg

Final	
011	Leonor Alves (GMP) <input type="text" value="2"/> <input type="text"/>
	Maria Cardoso (AKCR) <input type="text" value="6"/> <input type="text"/>
013	Leonor Alves (GMP) <input type="text" value="1"/> <input type="text"/>
	Matilde Pinheiro (UDCAS) <input type="text" value="5"/> <input type="text"/>
015	Maria Cardoso (AKCR) <input type="text" value="2"/> <input type="text"/>
	Matilde Pinheiro (UDCAS) <input type="text" value="1"/> <input type="text"/>

D1 - A5 - Afternoon

1° Maria Cardoso (AKCR)

2° Matilde Pinheiro (UDCAS)

3° Leonor Alves (GMP)

Note

NoneAREA: None

Judge 1

Central Referee

Judge 2

C. Nacional de Juvenis Juniores e Seniores

Semi Kempo | Feminine | 14-15 Years | -54 Kg

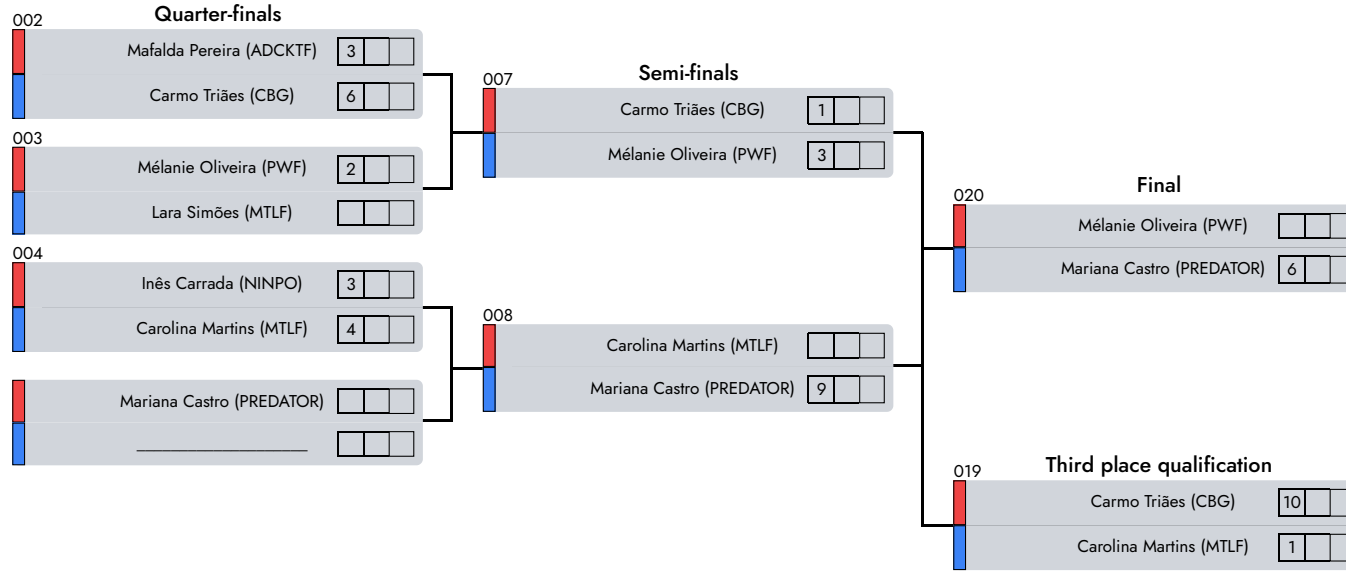

D1 - A5 - Afternoon

1° Mariana Castro (PREDATOR)

2° Mélanie Oliveira (PWF)

3° Carmo Triães (CBG)

Note
NoneAREA: None

Judge 1

Central Referee

Judge 2

C. Nacional de Juvenis Juniores e Seniores Semi Kempo | Feminine | 19-35 Years | +72 Kg

Final		
012	Carolina Costa (WFTGDBD)	5
	Vilma Lopes (UDCB)	4
014	Carolina Costa (WFTGDBD)	4
	Érica Aleixo (UDCAS)	7
016	Vilma Lopes (UDCB)	3
	Érica Aleixo (UDCAS)	2

D1 - A5 - Afternoon

1° Érica Aleixo (UDCAS)

2° Vilma Lopes (UDCB)

3° Vilma Lopes (UDCB)

Note
None
AREA: None
AREA: None
AREA: None
AREA: None
AREA: .

Judge 1

Central Referee

Judge 2

C. Nacional de Juvenis Juniores e Seniores

Semi Kempo | Feminine | 19-35 Years | -52 Kg

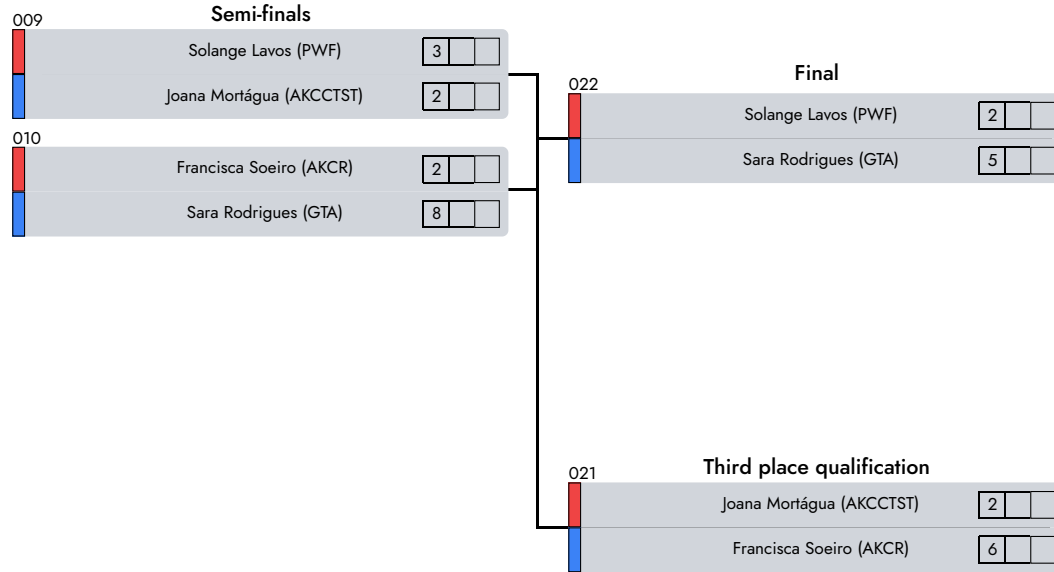

D1 - A5 - Afternoon

1° Sara Rodrigues (GTA)

2° Solange Lavos (PWF)

3° Francisca Soeiro (AKCR)

Note
NoneAREA: None
AREA: None
AREA: None

Judge 1

Central Referee

Judge 2

C. Nacional de Juvenis Juniores e Seniores

Semi Kempo | Masculine | 14-15 Years | -63 Kg

D1 - A6 - Afternoon

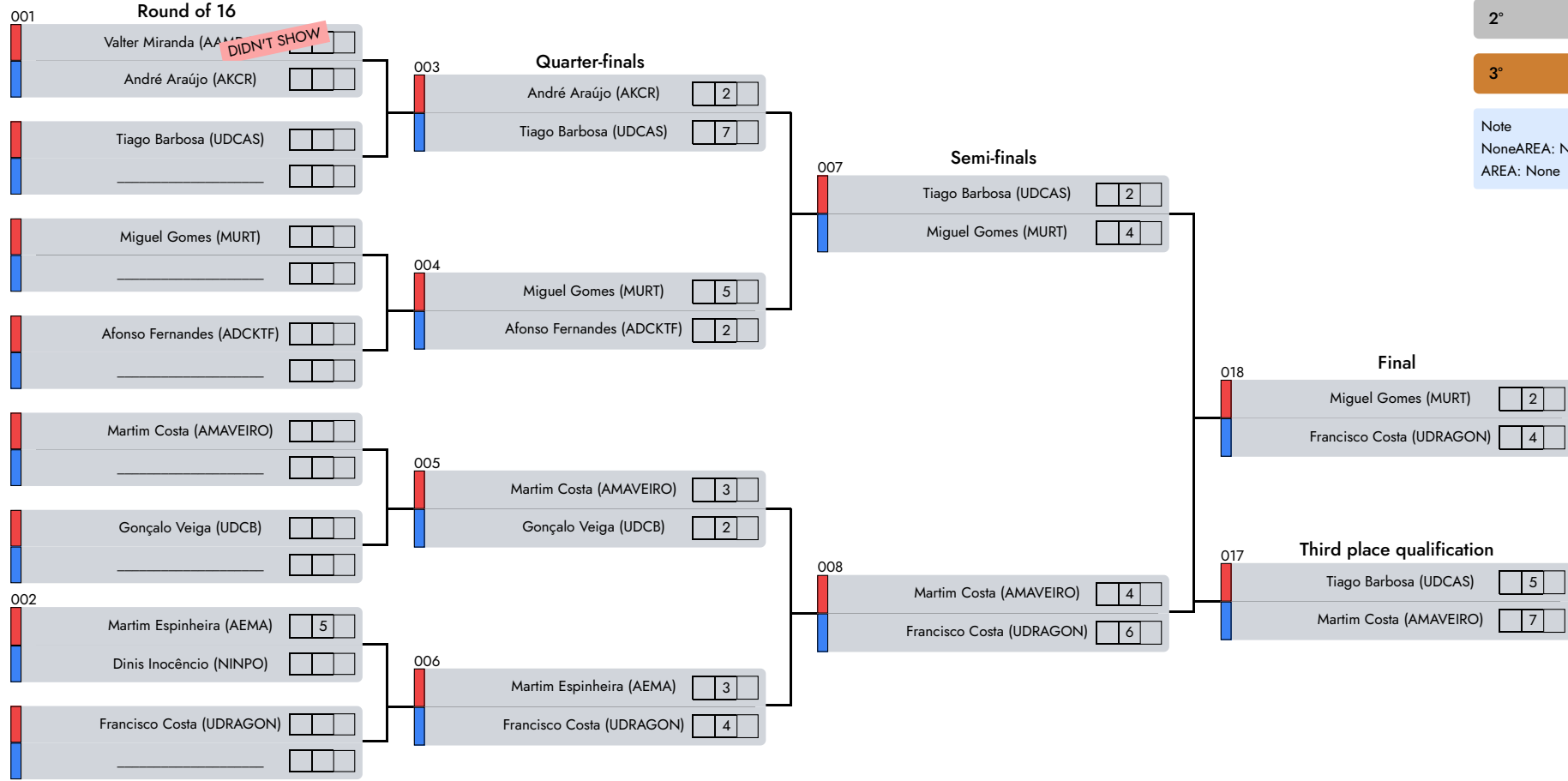

1° Francisco Costa (UDRAGON)

2° Miguel Gomes (MURT)

3° Martim Costa (AMAVEIRO)

Note
NoneAREA: None
AREA: None

Daniela Santos

Judge 1

Diogo Henriques

Central Referee

Marta Governo

Judge 2

C. Nacional de Juvenis Juniores e Seniores

Semi Kempo | Masculine | 14-15 Years | -53 Kg

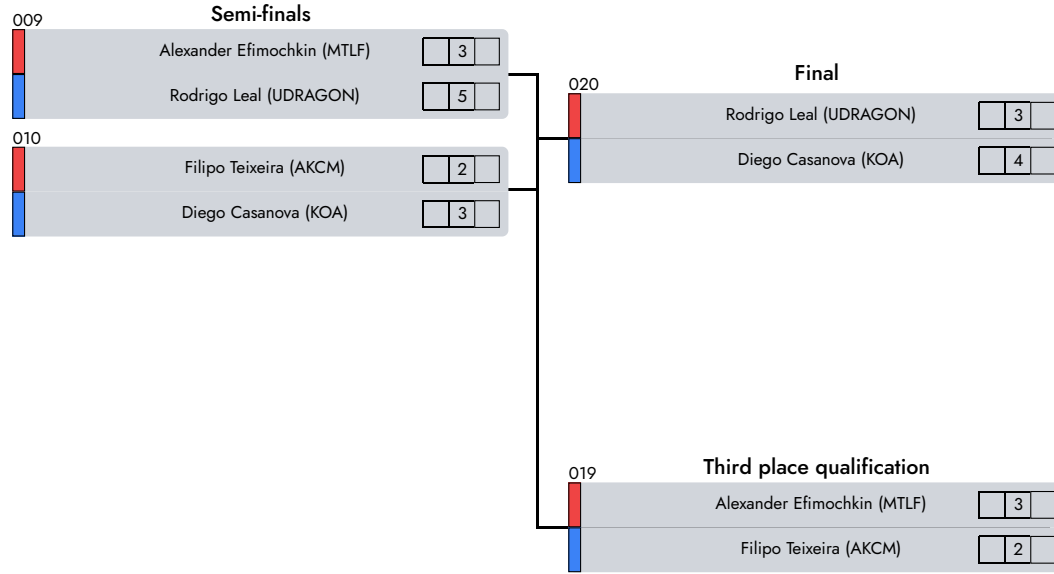

D1 - A6 - Afternoon

1° Diego Casanova (KOA)

2° Rodrigo Leal (UDRAGON)

3° Alexander Efimochkin (MTLF)



Note
NoneAREA: None
AREA: None

Daniela Santos
Judge 1

Diogo Henriques
Central Referee

Marta Governo
Judge 2

C. Nacional de Juvenis Juniores e Seniores Semi Kempo | Feminine | 19-35 Years | -62 Kg

Final	
011	
	
ANA FELGUEIRAS (FAC)	<input type="text" value="4"/>
Beatriz Marques (UDCAS)	<input type="text" value="3"/>
013	
	
ANA FELGUEIRAS (FAC)	<input type="text" value="3"/>
Carolina Carneiro (UDRAGON)	<input type="text" value="5"/>
015	
	
Beatriz Marques (UDCAS)	<input type="text" value="2"/>
Carolina Carneiro (UDRAGON)	<input type="text" value="3"/>

D1 - A6 - Afternoon

1° Carolina Carneiro (UDRAGON)

2° ANA FELGUEIRAS (FAC)

3° Beatriz Marques (UDCAS)

Note

NoneAREA: None

AREA: None

Daniela Santos

Judge 1

Diogo Henriques

Central Referee

Marta Governo

Judge 2

C. Nacional de Juvenis Juniores e Seniores Semi Kempo | Feminine | 19-35 Years | -57 Kg

Final	
012	Tatiana Aleixo (UDCAS) <input type="text" value="4"/>
	Susana Sampaio (PREDATOR) <input type="text" value="1"/>
014	Susana Sampaio (PREDATOR) ¹ RESIGNATION <input type="text" value=""/>
	Bárbara Silva (SPORTING) <input type="text" value="7"/>
016	Tatiana Aleixo (UDCAS) <input type="text" value="1"/>
	Bárbara Silva (SPORTING) <input type="text" value="7"/>

D1 - A6 - Afternoon

1° Bárbara Silva (SPORTING)

2° Tatiana Aleixo (UDCAS)

3° Susana Sampaio (PREDATOR)

Note

NoneAREA: None

AREA: None

AREA: None

Daniela Santos

Judge 1

Diogo Henriques

Central Referee

Marta Governo

Judge 2

C. Nacional de Juvenis Juniores e Seniores Semi Kempo | Feminine | 36-45 Years | -58 Kg

021

Final

Sara Lopes (ADKT)

--	--	--

Marina Cardona (CAMCTO)

DIDN'T SHOW

--	--	--

D1 - A6 - Afternoon

1°

Sara Lopes (ADKT)

2°

Marina Cardona (CAMCTO)

Note

NoneAREA: None

AREA: None

Daniela Santos

Judge 1

Diogo Henriques

Central Referee

Marta Governo

Judge 2

C. Nacional de Juvenis Juniores e Seniores

Light Kempo | Masculine | 14-15 Years | +73 Kg

029

Final

Bernardo Rolo (PWF)

9	14	12
---	----	----

David Souza (CAMA)

7	12	8
---	----	---

D2 - A1 - Morning

1°

Bernardo Rolo (PWF)

2°

David Souza (CAMA)

Note

NoneAREA: None

AREA: None

AREA: None

AREA: None

Judge 1

Central Referee

Judge 2

C. Nacional de Juvenis Juniores e Seniores Light Kempo | Feminine | 14-15 Years | -64 Kg

Final	
018	Leonor Alves (GMP) <input type="text" value="10"/> <input type="text" value="8"/> <input type="text" value="9"/>
	Matilde Pinheiro (UDCAS) <input type="text" value="6"/> <input type="text" value="3"/> <input type="text" value="7"/>
019	Leonor Alves (GMP) DISQUALIFIED <input type="text"/> <input type="text"/> <input type="text"/>
	Maria Cardoso (AKCR) <input type="text"/> <input type="text"/> <input type="text"/>
020	Matilde Pinheiro (UDCAS) RESIGNATION <input type="text"/> <input type="text"/> <input type="text"/>
	Maria Cardoso (AKCR) <input type="text"/> <input type="text"/> <input type="text"/>

D2 - A1 - Morning

1° Maria Cardoso (AKCR)

2° Leonor Alves (GMP)

3° Matilde Pinheiro (UDCAS)

Note

NoneAREA: None

Judge 1

Central Referee

Judge 2

C. Nacional de Juvenis Juniores e Seniores

Light Kempo | Masculine | 14-15 Years | -68 Kg

D2 - A1 - Morning

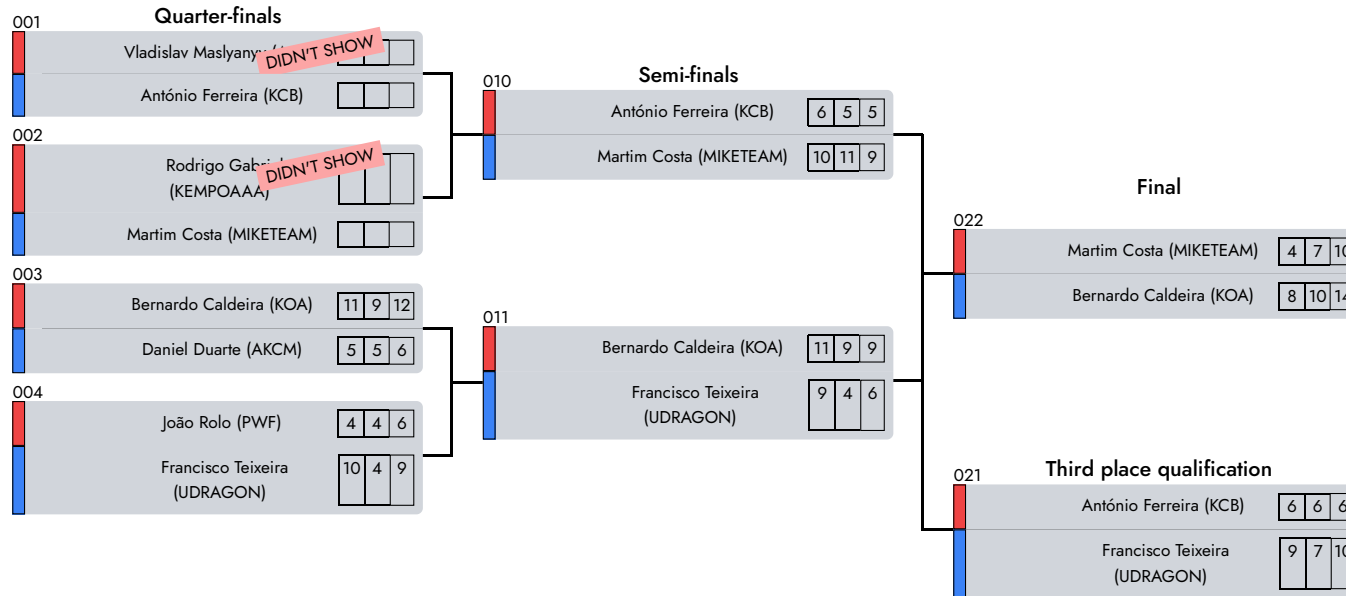

- 1° Bernardo Caldeira (KOA)
 - 2° Martim Costa (MIKETEAM)
 - 3° Francisco Teixeira (UDRAGON)
- Note
NoneAREA: None

Judge 1

Central Referee

Judge 2

C. Nacional de Juvenis Juniores e Seniores

Light Kempo | Masculine | 16-18 Years | -68 Kg

D2 - A1 - Morning

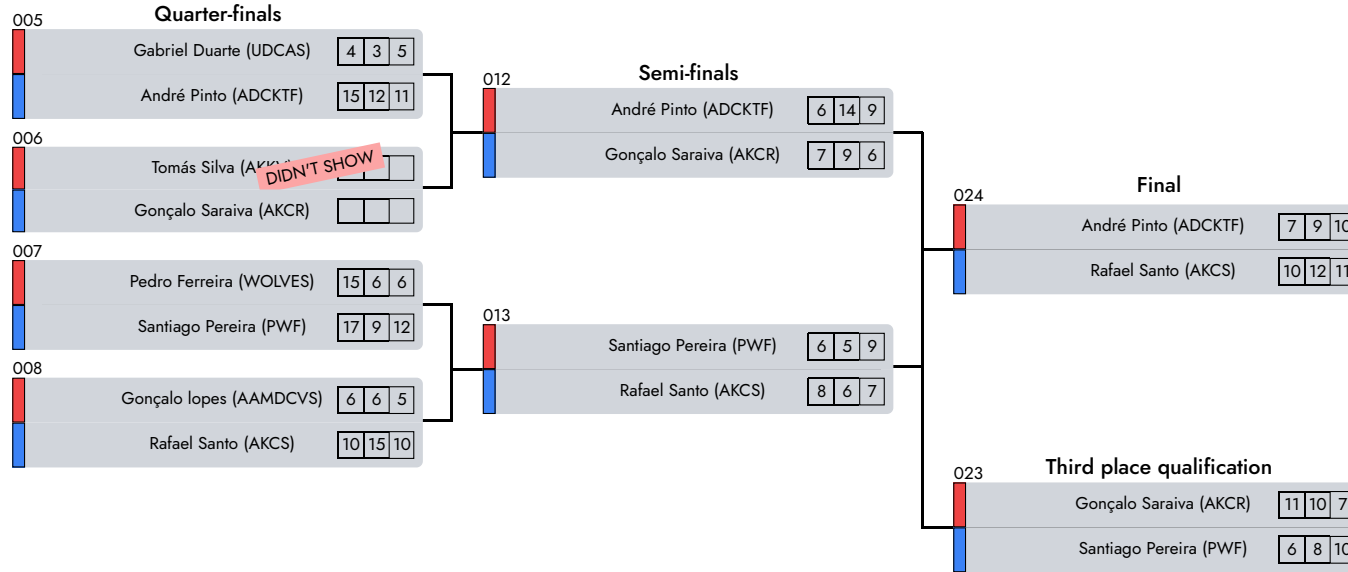

1° Rafael Santo (AKCS)

2° André Pinto (ADCKTF)

3° Gonçalo Saraiva (AKCR)

Note
NoneAREA: None

Judge 1

Central Referee

Judge 2

C. Nacional de Juvenis Juniores e Seniores

Light Kempo | Masculine | 16-18 Years | -78 Kg

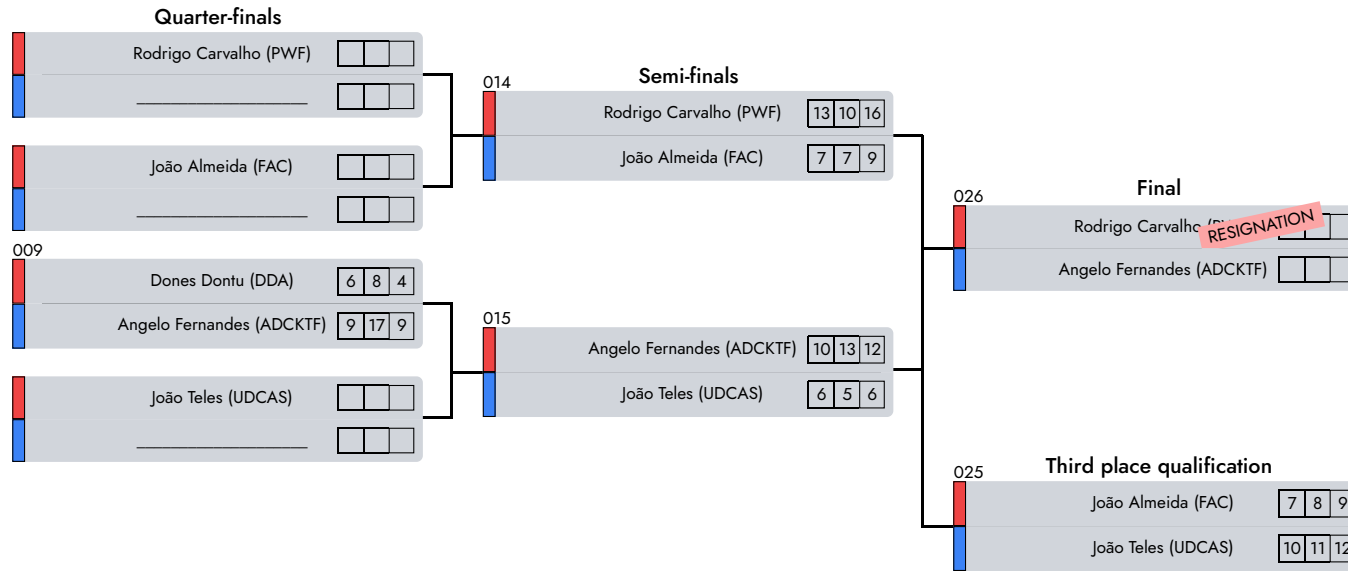

D2 - A1 - Morning

1°	Angelo Fernandes (ADCKTF)
2°	Rodrigo Carvalho (PWF)
3°	João Teles (UDCAS)

Note
NoneAREA: None

Judge 1

Central Referee

Judge 2

C. Nacional de Juvenis Juniores e Seniores

Light Kempo | Masculine | 16-18 Years | -73 Kg

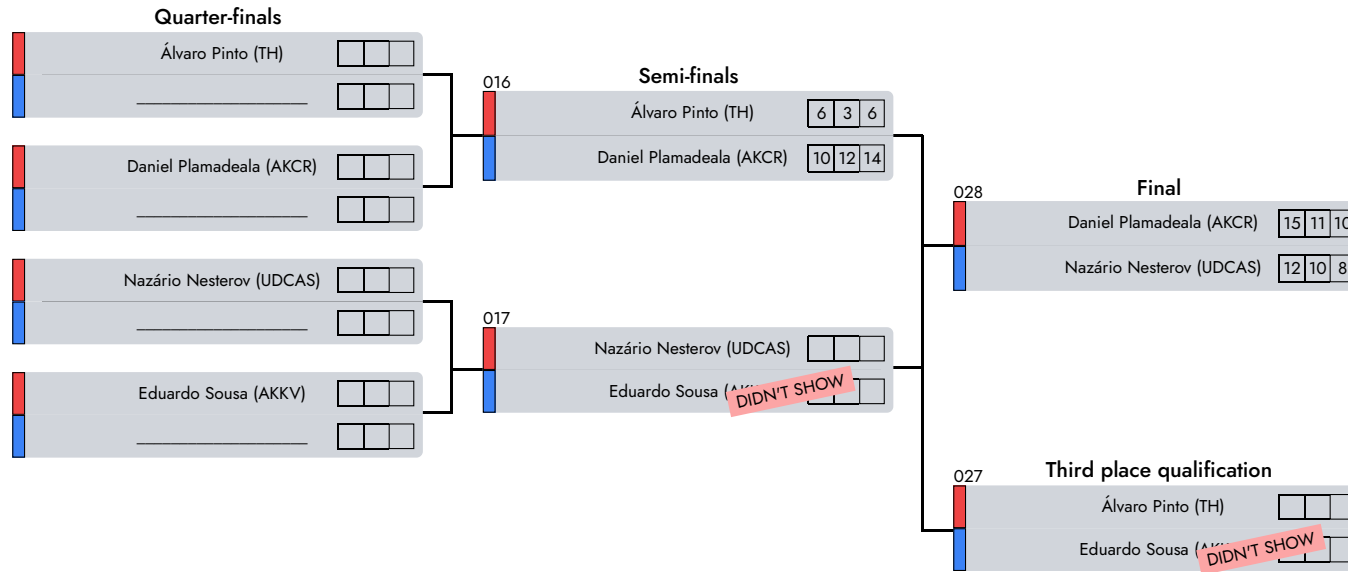

D2 - A1 - Morning

1°	Daniel Plamadeala (AKCR)
2°	Nazário Nesterov (UDCAS)
3°	Álvaro Pinto (TH)

Note
NoneAREA: None

Judge 1

Central Referee

Judge 2

C. Nacional de Juvenis Juniores e Seniores

Light Kempo | Masculine | 14-15 Years | -63 Kg

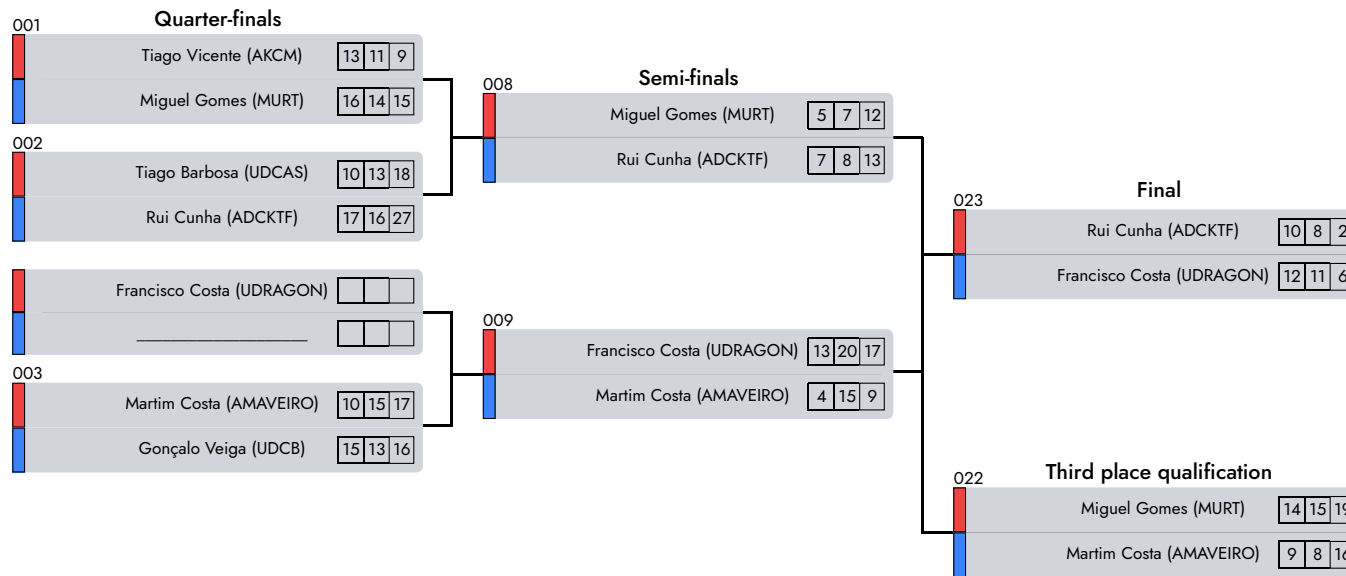

D2 - A2 - Morning

1°	Francisco Costa (UDRAGON)
2°	Rui Cunha (ADCKTF)
3°	Miguel Gomes (MURT)
Note	No notes

Judge 1

Central Referee

Judge 2

C. Nacional de Juvenis Juniores e Seniores Light Kempo | Feminine | 14-15 Years | -59 Kg

	Final	
016	Maria Oliveira (NINPO)	7 7 6
	Inês Mota (PREDATOR)	11 11 5
018	Maria Oliveira (NINPO)	7 6 12
	Adriana Dias (ADCV)	8 2 6
020	Inês Mota (PREDATOR)	8 5 17
	Adriana Dias (ADCV)	5 10 8

D2 - A2 - Morning

1° Inês Mota (PREDATOR)

2° Maria Oliveira (NINPO)

3° Adriana Dias (ADCV)

Note
No notes

Judge 1

Central Referee

Judge 2

C. Nacional de Juvenis Juniores e Seniores

Light Kempo | Masculine | 14-15 Years | -53 Kg

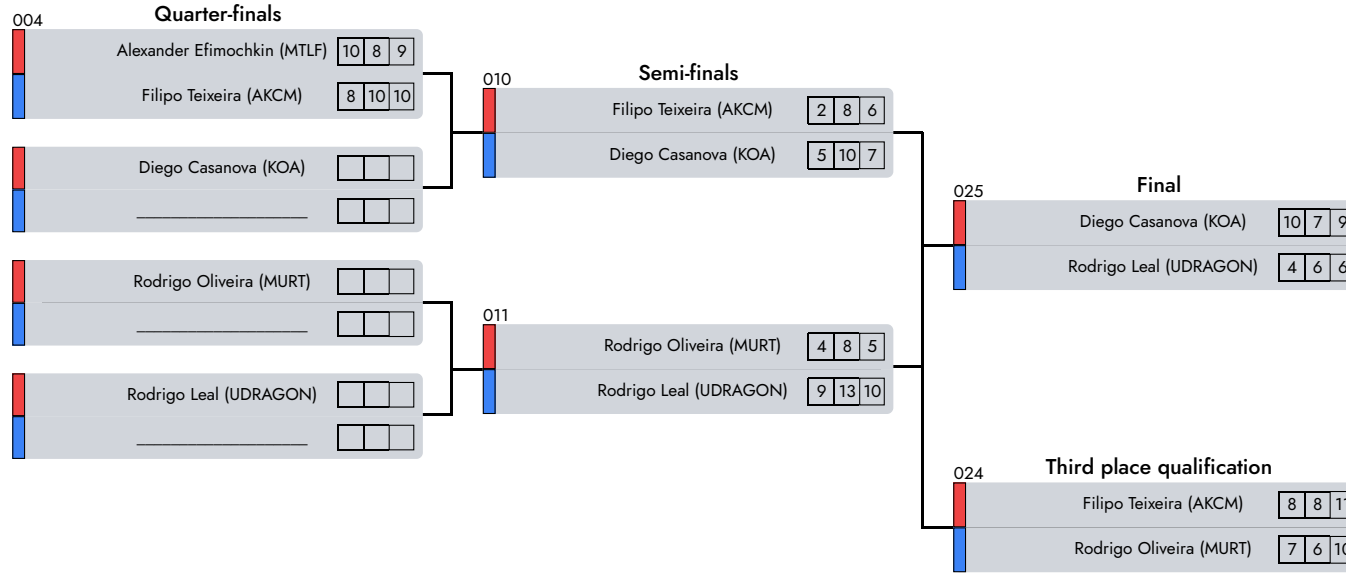

D2 - A2 - Morning

1° Diego Casanova (KOA)

2° Rodrigo Leal (UDRAGON)

3° Filipo Teixeira (AKCM)

Note
NoneAREA: None

Judge 1

Central Referee

Judge 2

C. Nacional de Juvenis Juniores e Seniores

Light Kempo | Feminine | 16-18 Years | -47 Kg

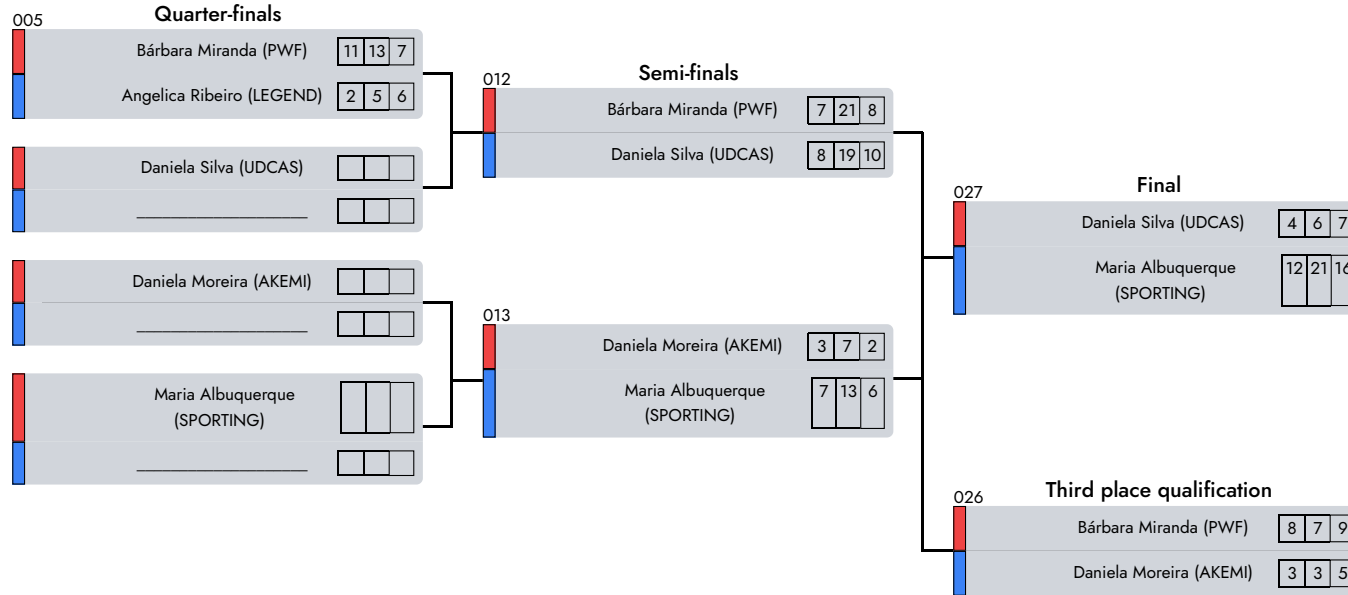

D2 - A2 - Morning

1° Maria Albuquerque (SPORTING)

2° Daniela Silva (UDCAS)

3° Bárbara Miranda (PWF)

Note
 NoneAREA: None

Judge 1

Central Referee

Judge 2

C. Nacional de Juvenis Juniores e Seniores Light Kempo | Feminine | 16-18 Years | -62 Kg

Final	
017	Raquel Alves (SPORTING) 11 9 12
	Joana Sequeira (AKKV) 7 3 9
019	Raquel Alves (SPORTING) 12 13 18
	Margarida Silva (MTLF) 10 9 12
021	Joana Sequeira (AKKV) RESIGNATION 0 0 0
	Margarida Silva (MTLF) 1 1 1

D2 - A2 - Morning

1° Raquel Alves (SPORTING)

2° Margarida Silva (MTLF)

3° Joana Sequeira (AKKV)

Note
No notes

Judge 1

Central Referee

Judge 2

C. Nacional de Juvenis Juniores e Seniores

Light Kempo | Masculine | 16-18 Years | -58 Kg

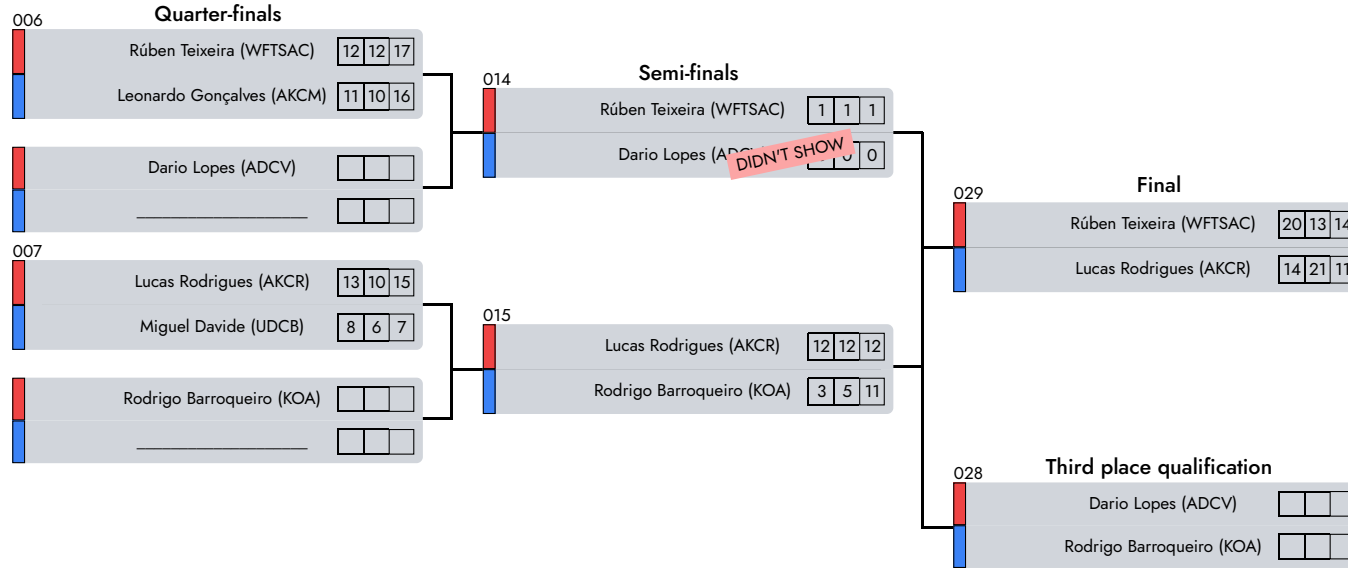

D2 - A2 - Morning

1° Rúben Teixeira (WFTSAC)

2° Lucas Rodrigues (AKCR)

3° Rodrigo Barroqueiro (KOA)

Note
 NoneAREA: None

Judge 1

Central Referee

Judge 2

C. Nacional de Juvenis Juniores e Seniores

Light Kempo | Masculine | 14-15 Years | -58 Kg

D2 - A3 - Morning

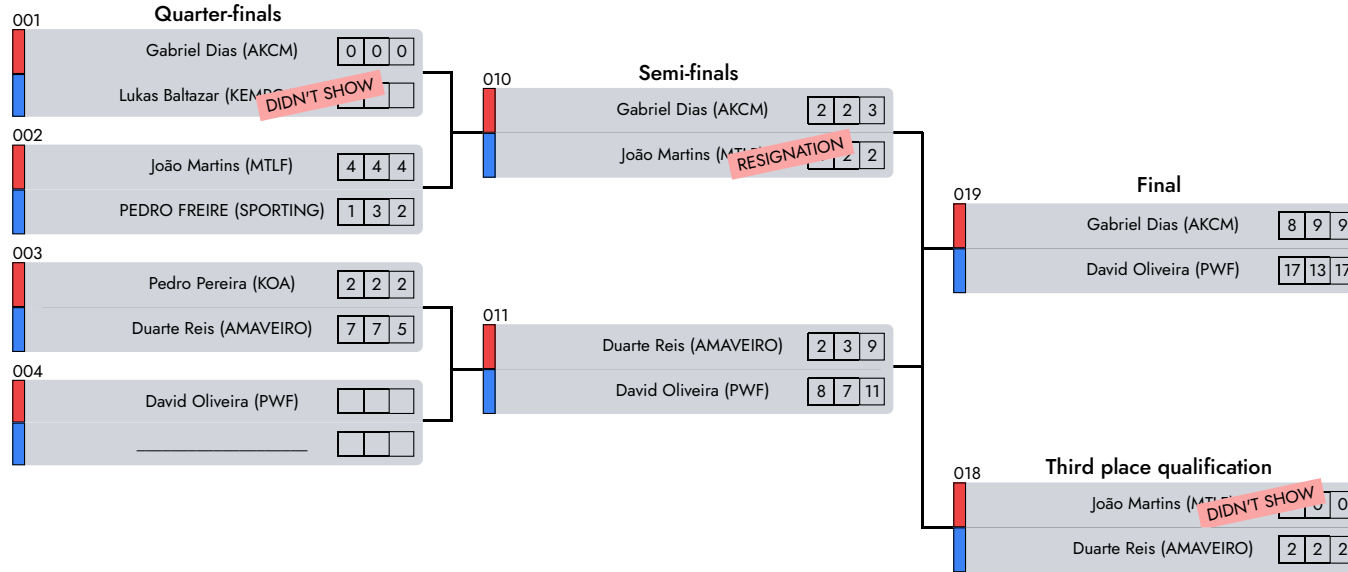

1° David Oliveira (PWF)

2° Gabriel Dias (AKCM)

3° Duarte Reis (AMAVEIRO)

Note
NoneAREA: None

Judge 1

Central Referee

Judge 2

C. Nacional de Juvenis Juniores e Seniores

Light Kempo | Feminine | 14-15 Years | -49 Kg

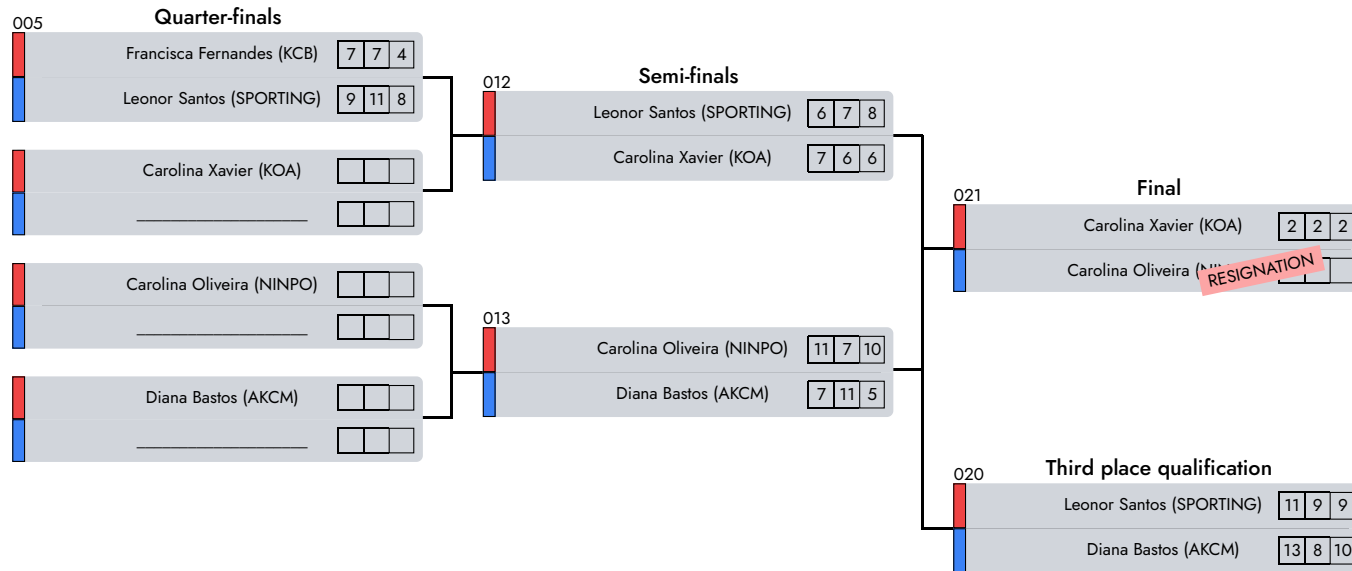

D2 - A3 - Morning

1° Carolina Xavier (KOA)

2° Carolina Oliveira (NINPO)

3° Diana Bastos (AKCM)

Note
NoneAREA: None

Judge 1

Central Referee

Judge 2

C. Nacional de Juvenis Juniores e Seniores

Light Kempo | Masculine | 16-18 Years | -63 Kg

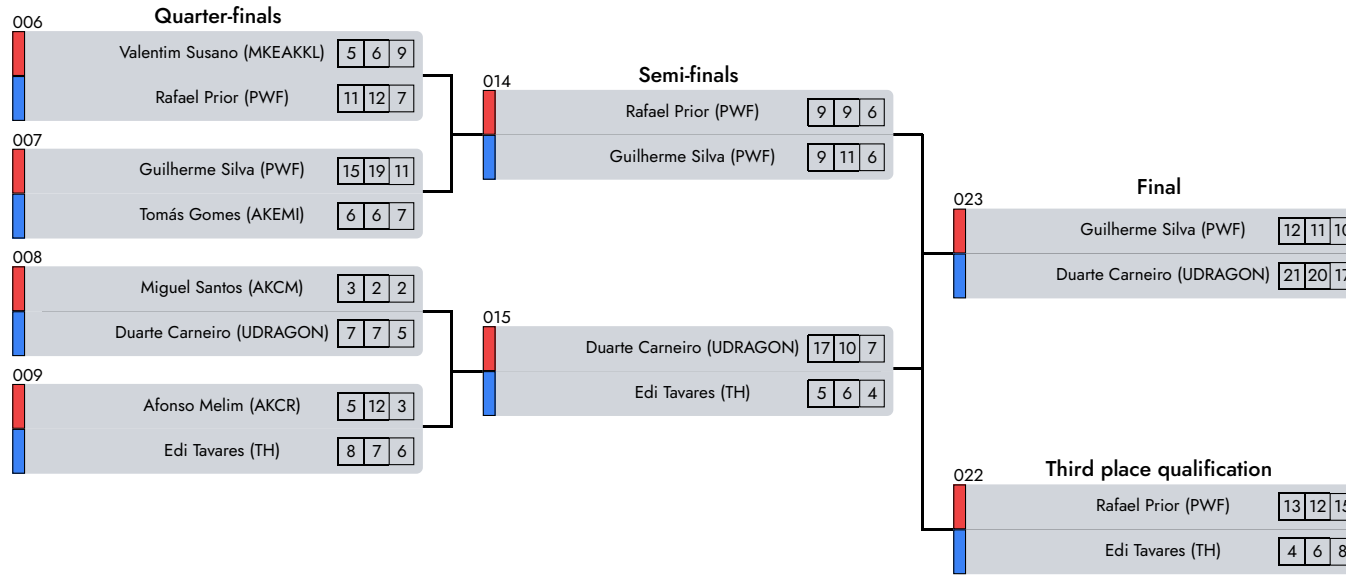

D2 - A3 - Morning

1° Duarte Carneiro (UDRAGON)

2° Guilherme Silva (PWF)

3° Rafael Prior (PWF)

Note
NoneAREA: None

Judge 1

Central Referee

Judge 2

C. Nacional de Juvenis Juniores e Seniores

Light Kempo | Feminine | 16-18 Years | -52 Kg

026

Final

Leonor Sousa (AKCM)

13	16	16
----	----	----

Matilde Freitas (WOLVES)

7	18	10
---	----	----

D2 - A3 - Morning

1° Leonor Sousa (AKCM)

2° Matilde Freitas (WOLVES)

Note

NoneAREA: None

AREA: None

Judge 1

Central Referee

Judge 2

C. Nacional de Juvenis Juniores e Seniores

Light Kempo | Masculine | 16-18 Years | -53 Kg

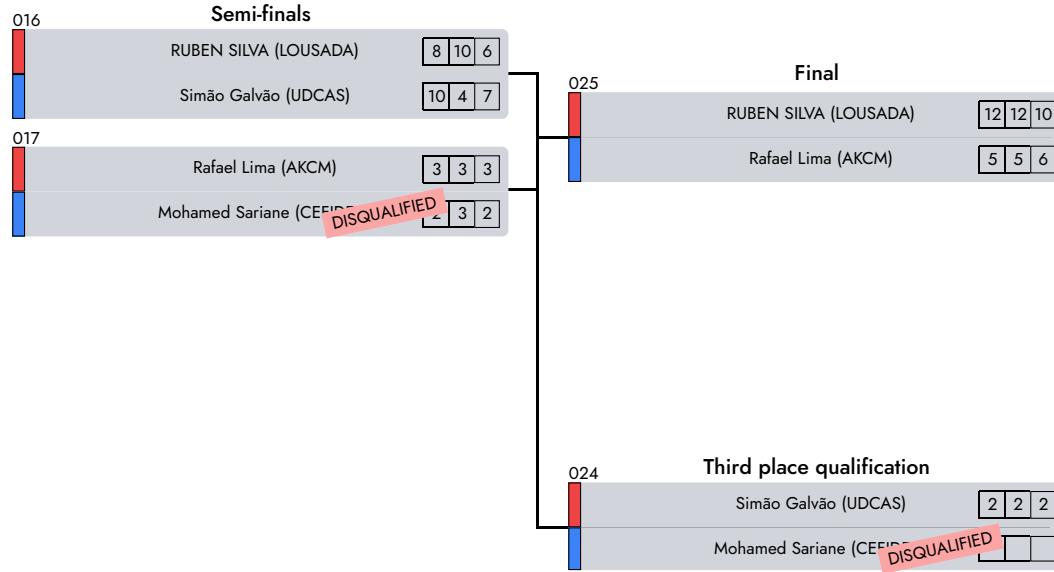

D2 - A3 - Morning

1° RUBEN SILVA (LOUSADA)

2° Rafael Lima (AKCM)

3° Simão Galvão (UDCAS)

Note
NoneAREA: None

Judge 1

Central Referee

Judge 2

C. Nacional de Juvenis Juniores e Seniores

Light Kempo | Feminine | 14-15 Years | -54 Kg

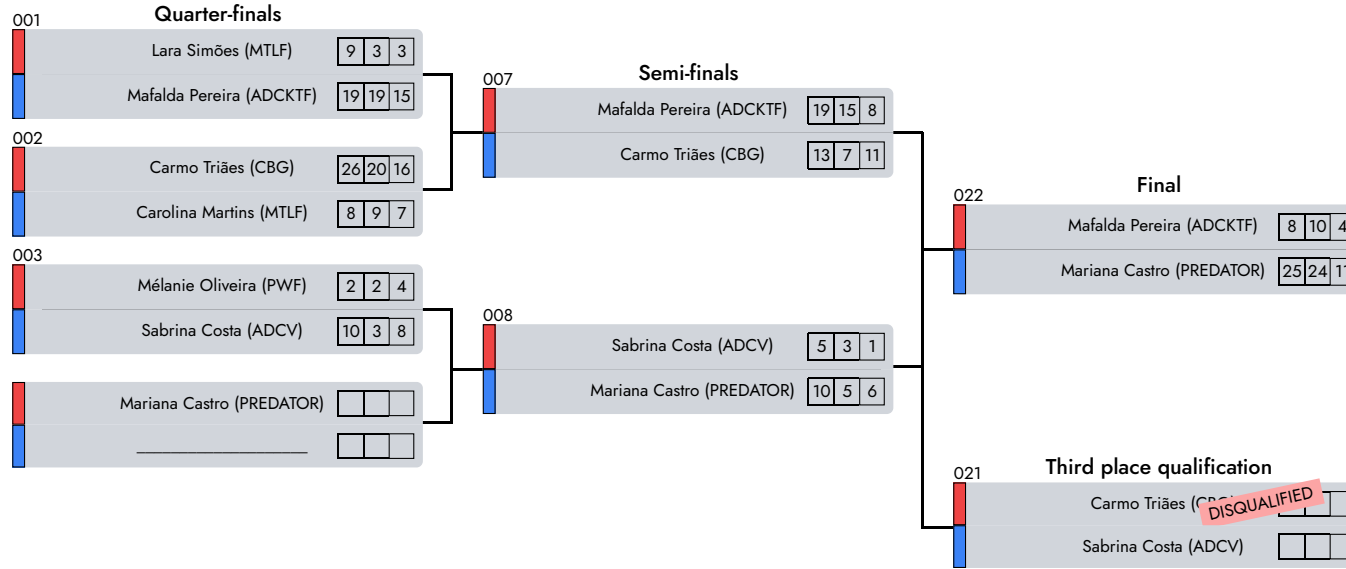

- D2 - A4 - Morning**
- 1° Mariana Castro (PREDATOR)
 - 2° Mafalda Pereira (ADCKTF)
 - 3° Sabrina Costa (ADCV)
- Note
NoneAREA: None





Judge 1

Central Referee

Judge 2

C. Nacional de Juvenis Juniores e Seniores

Light Kempo | Feminine | 14-15 Years | +64 Kg

Final	
015	
	Nuria Martins (PWF) 17 14 11
	Isabel Silva (MIKETEAM) 4 5 2
017	
	Nuria Martins (PWF) 14 17 13
	ISABEL TEIXEIRA (LEGEND) 3 5 2
019	
	Isabel Silva (MIKETEAM) 11 11 6
	ISABEL TEIXEIRA (LEGEND) 9 2 3

D2 - A4 - Morning

1°	Nuria Martins (PWF)
2°	Isabel Silva (MIKETEAM)
3°	ISABEL TEIXEIRA (LEGEND)
Note NoneAREA: None	

Judge 1

Central Referee

Judge 2

C. Nacional de Juvenis Juniores e Seniores

Light Kempo | Masculine | 14-15 Years | -43 Kg

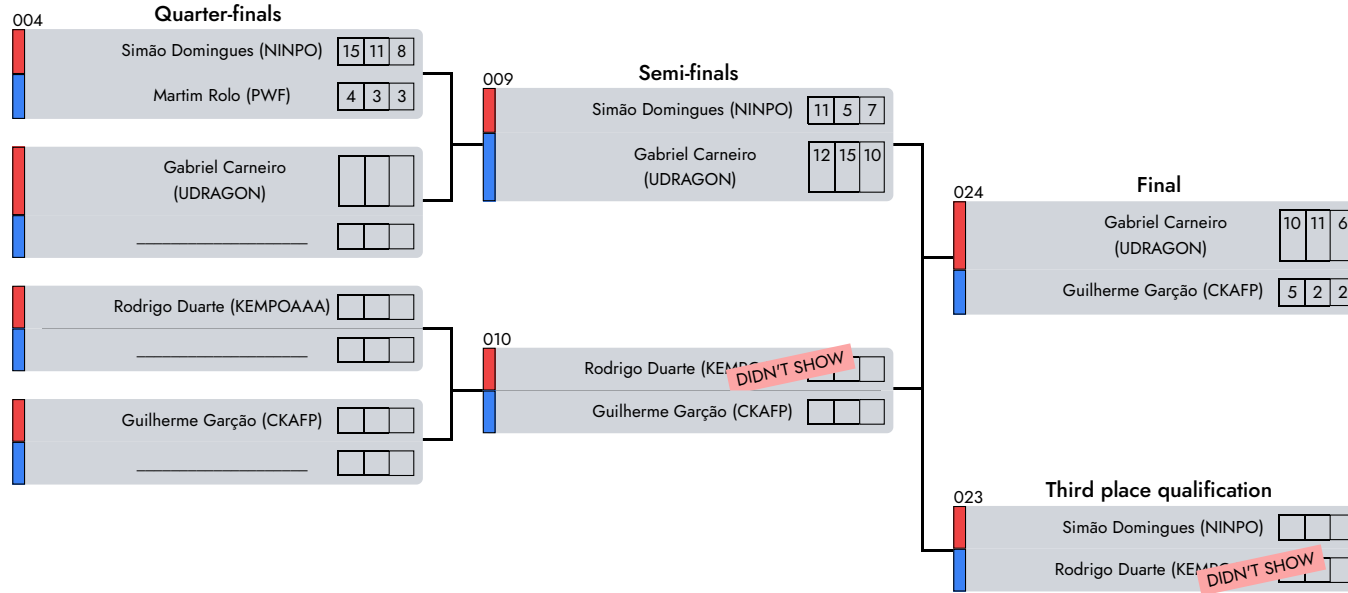

D2 - A4 - Morning

1°	Gabriel Carneiro (UDRAGON)
2°	Guilherme Garção (CKAFP)
3°	Simão Domingues (NINPO)

Note
 NoneAREA: None

Judge 1

Central Referee

Judge 2

C. Nacional de Juvenis Juniores e Seniores

Light Kempo | Feminine | 16-18 Years | -57 Kg

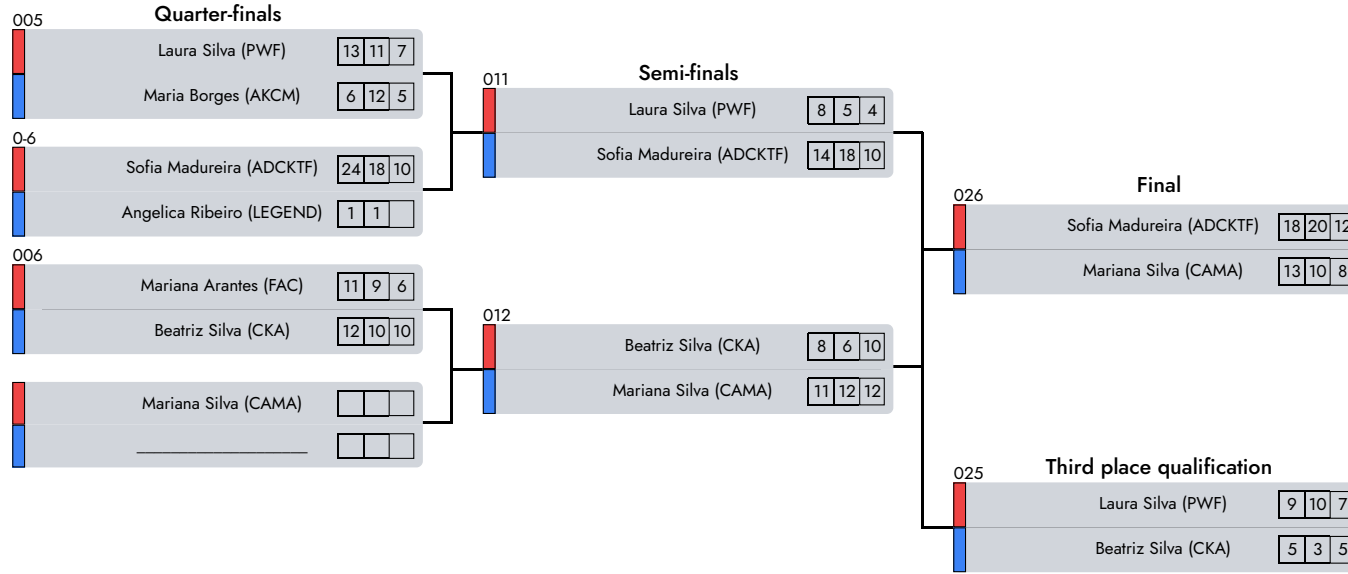

D2 - A4 - Morning

1° Sofia Madureira (ADCKTF)

2° Mariana Silva (CAMA)

3° Laura Silva (PWF)

Note
 NoneAREA: None

Judge 1

Central Referee

Judge 2

C. Nacional de Juvenis Juniores e Seniores Light Kempo | Feminine | 16-18 Years | +72 Kg

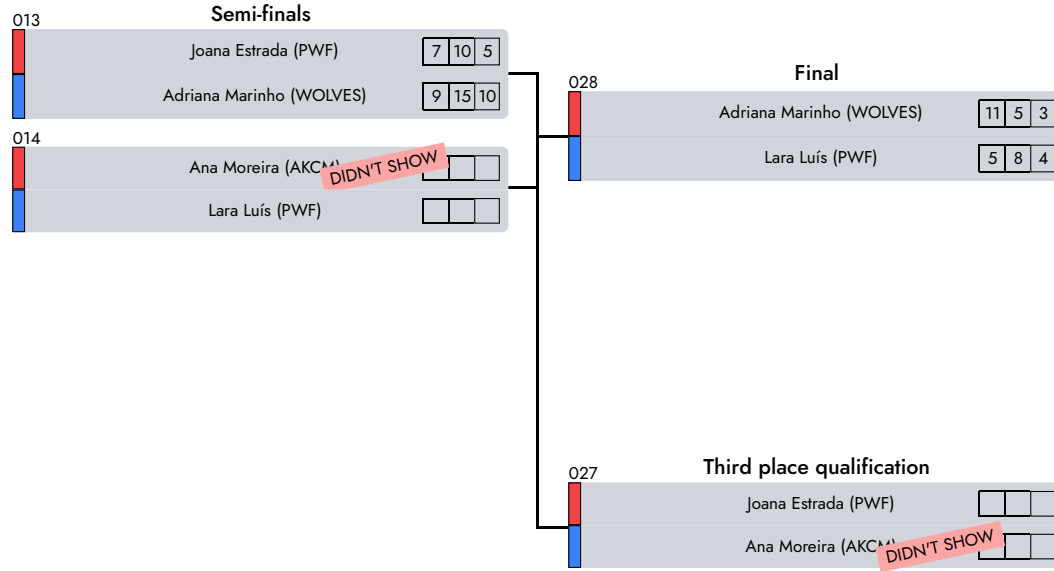

D2 - A4 - Morning

1° Lara Luís (PWF)

2° Adriana Marinho (WOLVES)

3° Joana Estrada (PWF)

Note
None
AREA: None

Judge 1

Central Referee

Judge 2

C. Nacional de Juvenis Juniores e Seniores

Light Kempo | Masculine | 16-18 Years | -88 Kg

Final	
016	
 	
Tiago Silva (CKA)	8 10 4
António Albuquerque (SPORTING)	14 15 10
018	
 	
Tiago Silva (CKA)	8 8 7
Bruno D'Souza (CEFIDEC)	4 2 1
020	
 	
António Albuquerque (SPORTING)	21 19 12
Bruno D'Souza (CEFIDEC)	3 3 2

D2 - A4 - Morning

1° António Albuquerque (SPORTING)

2° Tiago Silva (CKA)

3° Bruno D'Souza (CEFIDEC)

Note

NoneAREA: None

Judge 1

Central Referee

Judge 2

C. Nacional de Juvenis Juniores e Seniores

Full Kempo | Masculine | 19-40 Years | -72 Kg

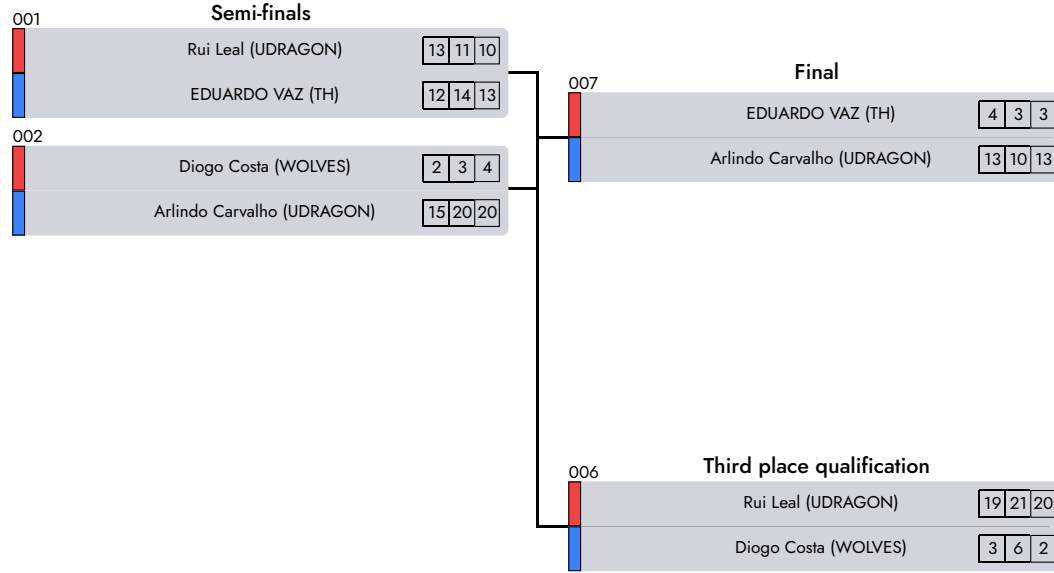

D2 - A5 - Morning

1° Arlindo Carvalho (UDRAGON)

2° EDUARDO VAZ (TH)

3° Rui Leal (UDRAGON)

Note
NoneAREA: None

Judge 1

Central Referee

Judge 2

C. Nacional de Juvenis Juniores e Seniores

Full Kempo | Masculine | 19-40 Years | -90 Kg

008

Final

Bruce Pereira (CEFIDEC)

--	--	--

David Tavares (GMP)

RESIGNATION

--	--	--

D2 - A5 - Morning

1°

Bruce Pereira (CEFIDEC)

2°

David Tavares (GMP)

Note

NoneAREA: None

Judge 1

Central Referee

Judge 2

C. Nacional de Juvenis Juniores e Seniores

Full Kempo | Masculine | 19-40 Years | -68 Kg

Final	
003	Rafael Grilo (UDCAS) DIDN'T SHOW <input type="text"/> <input type="text"/> <input type="text"/>
	Duarte Ferreira (MKEAKKL) <input type="text"/> <input type="text"/> <input type="text"/>
004	Rafael Grilo (UDCAS) DIDN'T SHOW <input type="text"/> <input type="text"/> <input type="text"/>
	Pedro Valido (MURT) <input type="text"/> <input type="text"/> <input type="text"/>
005	Duarte Ferreira (MKEAKKL) <input type="text"/> 3 <input type="text"/> 5 <input type="text"/> 3
	Pedro Valido (MURT) <input type="text"/> 7 <input type="text"/> 8 <input type="text"/> 8

D2 - A5 - Morning

1° Pedro Valido (MURT)

2° Duarte Ferreira (MKEAKKL)

3° Rafael Grilo (UDCAS)

Note

NoneAREA: None

Judge 1

Central Referee

Judge 2

C. Nacional de Juvenis Juniores e Seniores

Full Kempo | Masculine | 19-40 Years | +90 Kg

009

Final

Luis Faria (ADCKTF)

14 14 12

Jaime Freitas (CEFIDEC)

6 10 9

D2 - A5 - Morning

1°

Luis Faria (ADCKTF)

2°

Jaime Freitas (CEFIDEC)

Note

NoneAREA: None

Judge 1

Central Referee

Judge 2

C. Nacional de Juvenis Juniores e Seniores

Full Kempo | Masculine | 19-40 Years | -80 Kg

010

Final

André Doutor (AMAVEIRO)

16 12 12

Miguel Pereira (ADKT)

15 18 19

D2 - A5 - Morning

1° Miguel Pereira (ADKT)

2° André Doutor (AMAVEIRO)

Note

NoneAREA: None

Judge 1

Central Referee

Judge 2

C. Nacional de Juvenis Juniores e Seniores

Full Kempo | Feminine | 19-35 Years | -72 Kg

011

Final

TELMA FERNANDES (OSK)

14 16 11

Diana Silva (MIKETEAM)

10 10 8

D2 - A5 - Morning

1°

TELMA FERNANDES (OSK)

2°

Diana Silva (MIKETEAM)

Note

NoneAREA: None

Judge 1

Central Referee

Judge 2

C. Nacional de Juvenis Juniores e Seniores

Submission Kempo | Masculine | 19-40 Years | -93 Kg

024

Final

Jaime Freitas (CEFIDEC)

DIDN'T SHOW

--	--	--

David Tavares (GMP)

--	--	--

D2 - A5 - Morning

1°

David Tavares (GMP)

2°

Jaime Freitas (CEFIDEC)

Note

NoneAREA: None

Judge 1

Central Referee

Judge 2

C. Nacional de Juvenis Juniores e Seniores

Submission Kempo | Masculine | 19-40 Years | -68 Kg

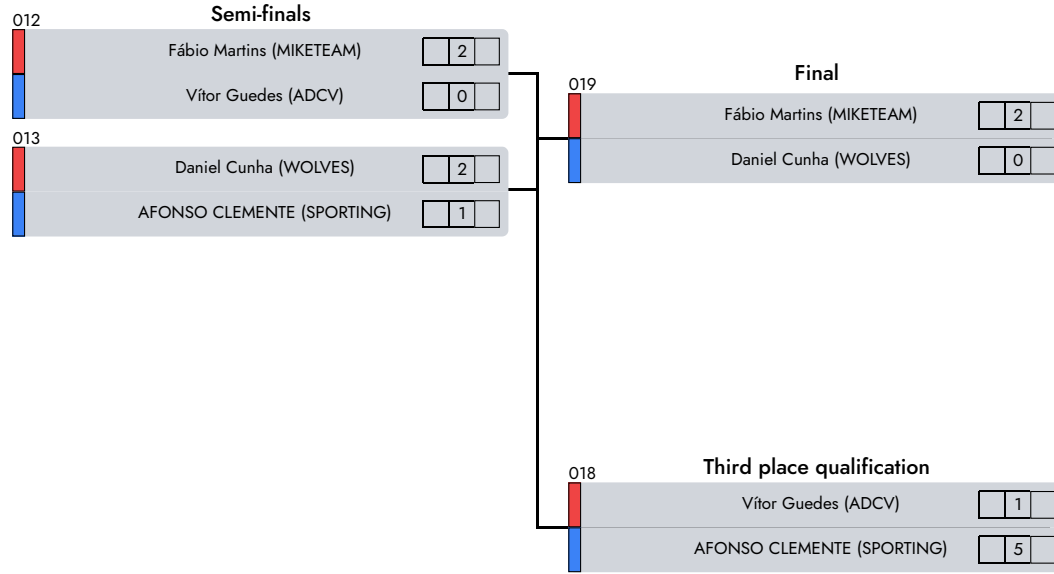

D2 - A5 - Morning

1° Fábio Martins (MIKETEAM)

2° Daniel Cunha (WOLVES)

3° AFONSO CLEMENTE (SPORTING)

Note
NoneAREA: None

Judge 1

Central Referee

Judge 2

C. Nacional de Juvenis Juniores e Seniores

Submission Kempo | Masculine | 19-40 Years | -73 Kg

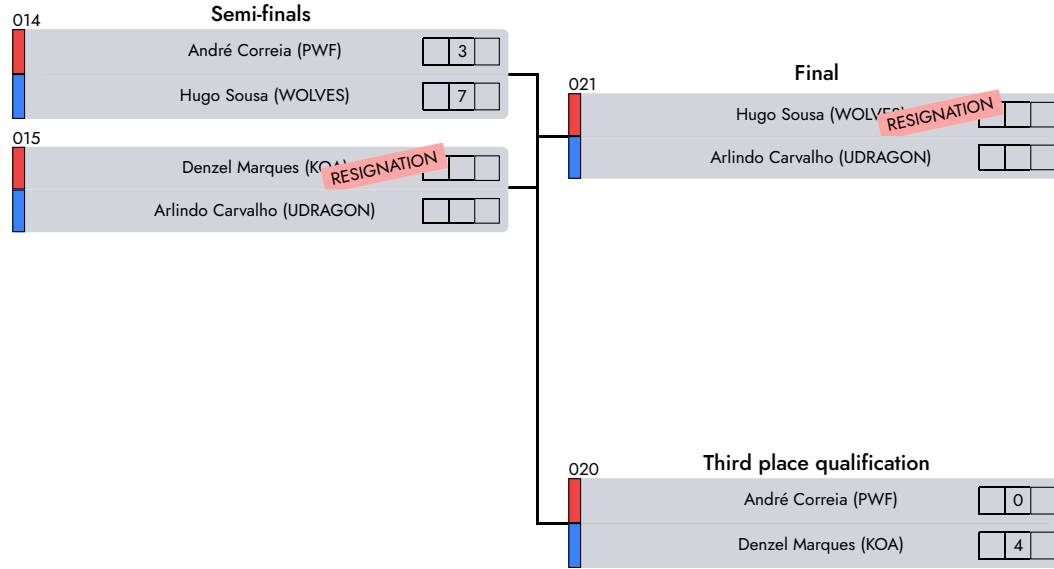

D2 - A5 - Morning

1° Arlindo Carvalho (UDRAGON)

2° Hugo Sousa (WOLVES)

3° Denzel Marques (KOA)

Note
 NoneAREA: None

Judge 1

Central Referee

Judge 2

C. Nacional de Juvenis Juniores e Seniores

Submission Kempo | Masculine | 19-40 Years | -88 Kg

D2 - A5 - Morning

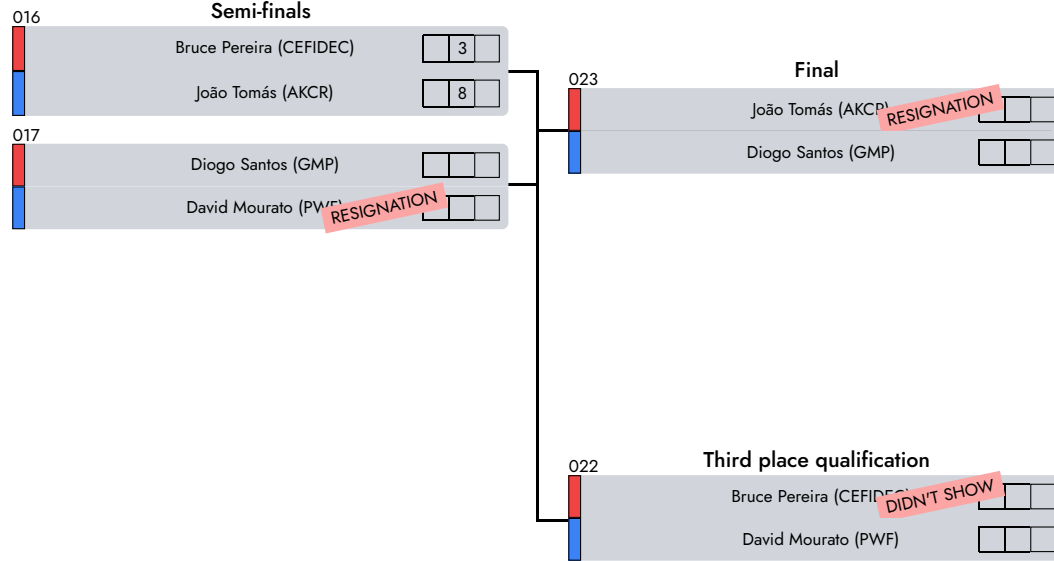

1° Diogo Santos (GMP)

2° João Tomás (AKCR)

3° David Mourato (PWF)

Note
NoneAREA: None

Judge 1

Central Referee

Judge 2

C. Nacional de Juvenis Juniores e Seniores

Full Kempo | Masculine | 19-40 Years | -65 Kg

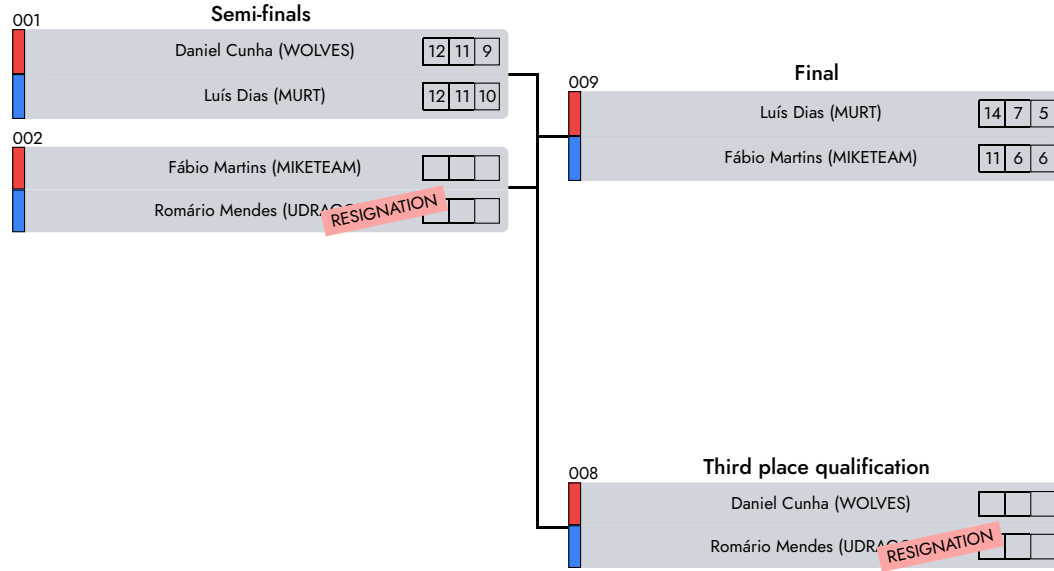

D2 - A6 - Morning

1° Luís Dias (MURT)

2° Fábio Martins (MIKETEAM)

3° Daniel Cunha (WOLVES)

Note
 NoneAREA: None
 AREA: None

Daniela Santos
 Judge 1

Diogo Henriques
 Central Referee

Marta Governo
 Judge 2

C. Nacional de Juvenis Juniores e Seniores

Full Kempo | Masculine | 19-40 Years | -76 Kg

012

Final

Gonçalo Fernandes (MIKETEAM)



Ruben Perez (UDRAGON)

DIDN'T SHOW



D2 - A6 - Morning

1° Gonçalo Fernandes (MIKETEAM)

2° Ruben Perez (UDRAGON)

Note

NoneAREA: None

AREA: None

Daniela Santos

Judge 1

Diogo Henriques

Central Referee

Marta Governo

Judge 2

C. Nacional de Juvenis Juniores e Seniores

Full Kempo | Masculine | 19-40 Years | -62 Kg

Final				
005				
	Henrique Ferraz (WOLVES) <table border="1"><tr><td>0</td><td>2</td><td>2</td></tr></table>	0	2	2
0	2	2		
	João Silva (MURT) <table border="1"><tr><td>4</td><td>8</td><td>7</td></tr></table>	4	8	7
4	8	7		
006				
	Henrique Ferraz (WOLVES) <table border="1"><tr><td>5</td><td>2</td><td>3</td></tr></table>	5	2	3
5	2	3		
	Tiago Teixeira (PREDATOR) <table border="1"><tr><td>15</td><td>8</td><td>7</td></tr></table>	15	8	7
15	8	7		
007				
	João Silva (MURT) <table border="1"><tr><td>7</td><td>4</td><td>6</td></tr></table>	7	4	6
7	4	6		
	Tiago Teixeira (PREDATOR) <table border="1"><tr><td>17</td><td>3</td><td>5</td></tr></table>	17	3	5
17	3	5		

D2 - A6 - Morning

1° Tiago Teixeira (PREDATOR)

2° João Silva (MURT)

3° Henrique Ferraz (WOLVES)

Note

NoneAREA: None

AREA: None

AREA: None

Daniela Santos

Judge 1

Diogo Henriques

Central Referee

Marta Governo

Judge 2

C. Nacional de Juvenis Juniores e Seniores

Full Kempo | Masculine | 19-40 Years | -85 Kg

013

Final

Diogo Santos (GMP)

--	--	--

TIAGO MENDES (UDRAGON)

DIDN'T SHOW

--	--	--

D2 - A6 - Morning

1° Diogo Santos (GMP)

2° TIAGO MENDES (UDRAGON)

Note

NoneAREA: None

AREA: None

Daniela Santos

Judge 1

Diogo Henriques

Central Referee

Marta Governo

Judge 2

C. Nacional de Juvenis Juniores e Seniores

Full Kempo | Masculine | 41-65 Years | +10 Kg

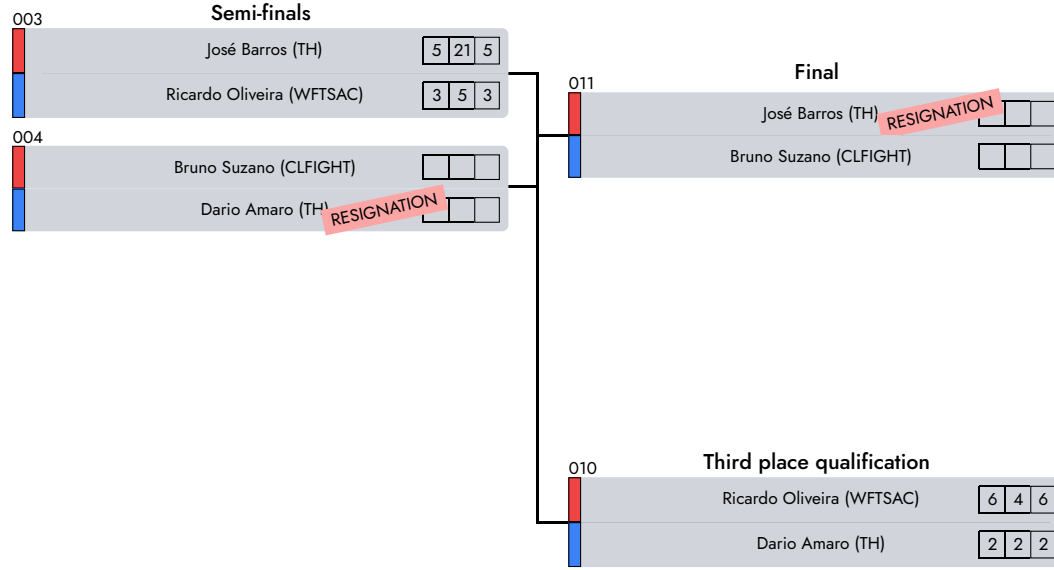

D2 - A6 - Morning

1° Bruno Suzano (CLFIGHT)

2° José Barros (TH)

3° Ricardo Oliveira (WFTSAC)

Note
 NoneAREA: None
 AREA: None
 AREA: None

Daniela Santos
 Judge 1

Diogo Henriques
 Central Referee

Marta Governo
 Judge 2

C. Nacional de Juvenis Juniores e Seniores

Submission Kempo | Feminine | 19-35 Years | -52 Kg

022

Final

Joana Mortágua (AKCCTST)

	4	
--	---	--

Solange Lavos (PWF)

RESIGNATION

--	--	--

D2 - A6 - Morning

1°

Joana Mortágua (AKCCTST)

2°

Solange Lavos (PWF)

Note

NoneAREA: None

AREA: None

Daniela Santos

Judge 1

Diogo Henriques

Central Referee

Marta Governo

Judge 2

C. Nacional de Juvenis Juniores e Seniores

Submission Kempo | Feminine | 19-35 Years | -57 Kg

023

Final

Tatiana Aleixo (UDCAS)

4

Bárbara Silva (SPORTING)

2

D2 - A6 - Morning

1°

Tatiana Aleixo (UDCAS)

2°

Bárbara Silva (SPORTING)

Note

NoneAREA: None

AREA: None

Daniela Santos

Judge 1

Diogo Henriques

Central Referee

Marta Governo

Judge 2

C. Nacional de Juvenis Juniores e Seniores

Submission Kempo | Masculine | 19-40 Years | -78 Kg

D2 - A6 - Morning

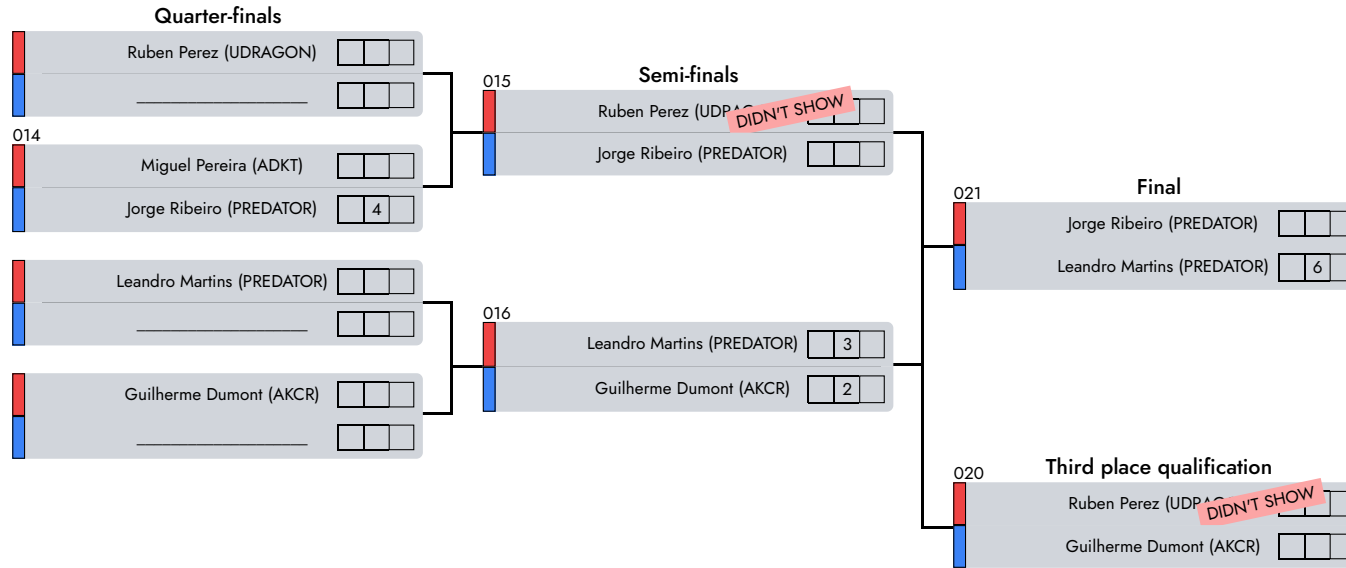

1° Leandro Martins (PREDATOR)

2° Jorge Ribeiro (PREDATOR)

3° Guilherme Dumont (AKCR)

Note
NoneAREA: None
AREA: None

Daniela Santos
Judge 1

Diogo Henriques
Central Referee

Marta Governo
Judge 2

C. Nacional de Juvenis Juniores e Seniores

Submission Kempo | Masculine | 41-50 Years | -73 Kg

024

Final

Ivo Furtado (RD)

--	--	--

José Aleixo (UDCAS)

RESIGNATION

--	--	--

D2 - A6 - Morning

1°

Ivo Furtado (RD)

2°

José Aleixo (UDCAS)

Note

NoneAREA: None

AREA: None

Daniela Santos

Judge 1

Diogo Henriques

Central Referee

Marta Governo

Judge 2

C. Nacional de Juvenis Juniores e Seniores

Submission Kempo | Masculine | 19-40 Years | -63 Kg

Final				
017	Henrique Ferraz (WOLVES)	<input type="text"/>	<input type="text"/>	<input type="text"/>
	Tiago Teixeira (PREDATOR)	<input type="text"/>	8	<input type="text"/>
018	Ivo Meireles (WOLVES)	<input type="text"/>	<input type="text"/>	<input type="text"/>
	Tiago Teixeira (PREDATOR)	<input type="text"/>	10	<input type="text"/>
019	Ivo Meireles (WOLVES)	<input type="text"/>	<input type="text"/>	<input type="text"/>
	Henrique Ferraz (WOLVES) RESIGNATION	<input type="text"/>	<input type="text"/>	<input type="text"/>

D2 - A6 - Morning

1° Tiago Teixeira (PREDATOR)

2° Ivo Meireles (WOLVES)

3° Henrique Ferraz (WOLVES)

Note

NoneAREA: None

AREA: None

Daniela Santos

Judge 1

Diogo Henriques

Central Referee

Marta Governo

Judge 2

C. Nacional de Juvenis Juniores e Seniores Knock Down | Masculine | 19-40 Years | +90 Kg

025

Final

Jeferson Moreira (ADCKTF)

--	--	--

Luis Faria (ADCKTF)

RESIGNATION

--	--	--

D2 - A6 - Morning

1°

Jeferson Moreira (ADCKTF)

2°

Luis Faria (ADCKTF)

Note

NoneAREA: None

AREA: None

Daniela Santos

Judge 1

Diogo Henriques

Central Referee

Marta Governo

Judge 2

C. Nacional de Juvenis Juniores e Seniores

Light Kempo | Masculine | 19-40 Years | -73 Kg

D2 - A1 - Afternoon

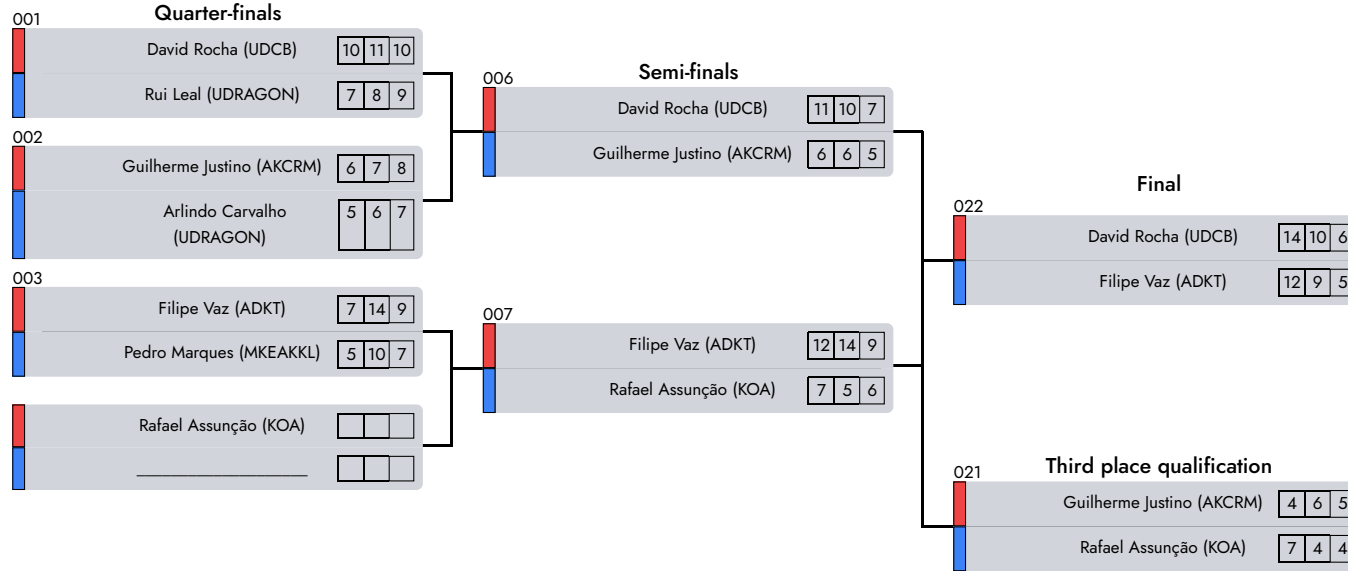

1° David Rocha (UDCB)

2° Filipe Vaz (ADKT)

3° Guilherme Justino (AKCRM)

Note
NoneAREA: None

Judge 1

Central Referee

Judge 2

C. Nacional de Juvenis Juniores e Seniores

Light Kempo | Masculine | 19-40 Years | -63 Kg

D2 - A1 - Afternoon

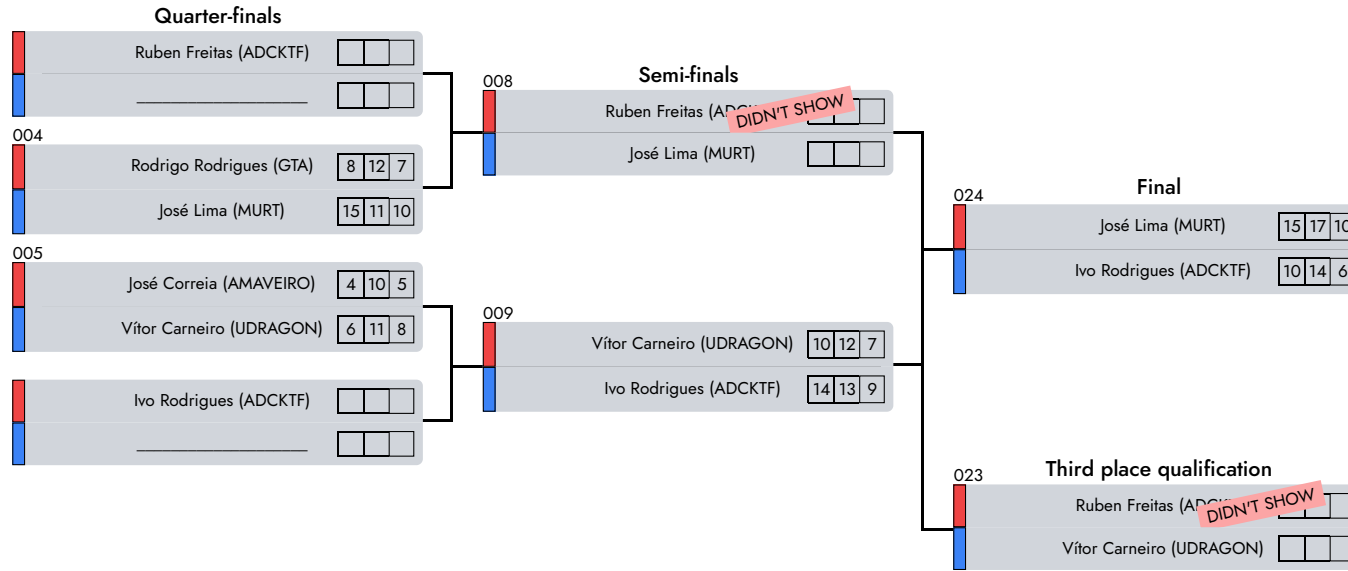

1° José Lima (MURT)

2° Ivo Rodrigues (ADCKTF)

3° Vítor Carneiro (UDRAGON)

Note
 NoneAREA: None

Judge 1

Central Referee

Judge 2

C. Nacional de Juvenis Juniores e Seniores

Light Kempo | Feminine | 19-35 Years | -62 Kg

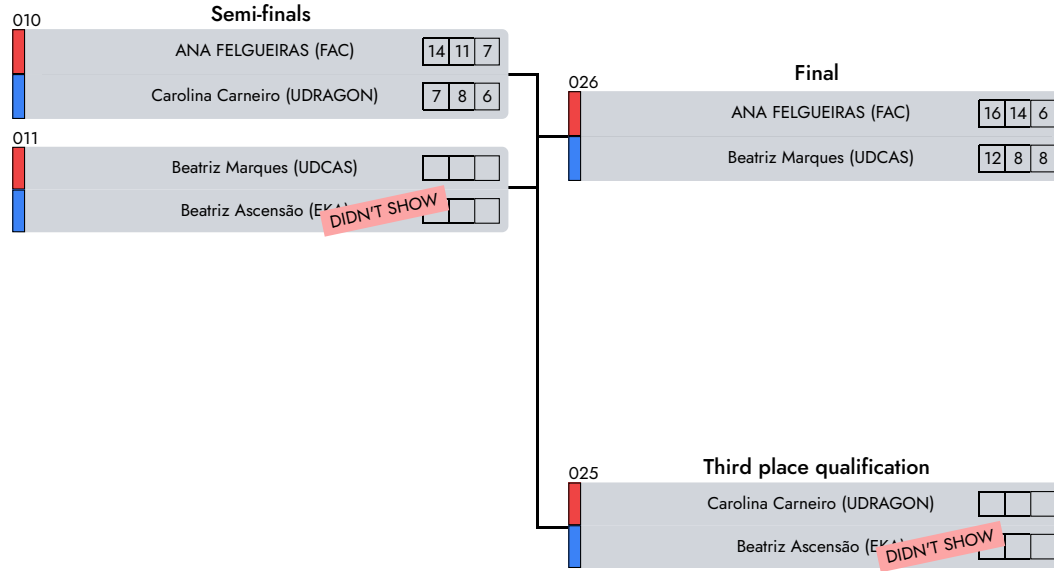

D2 - A1 - Afternoon

1° ANA FELGUEIRAS (FAC)

2° Beatriz Marques (UDCAS)

3° Carolina Carneiro (UDRAGON)

Note
 NoneAREA: None

Judge 1

Central Referee

Judge 2

C. Nacional de Juvenis Juniores e Seniores

Light Kempo | Feminine | 19-35 Years | -67 Kg

027

Final

Andreia Machado (TH)

5	4	5
---	---	---

Marta Coelho (ADKT)

7	6	7
---	---	---

D2 - A1 - Afternoon

1° Marta Coelho (ADKT)

2° Andreia Machado (TH)

Note





NoneAREA: None

Judge 1

Central Referee

Judge 2

C. Nacional de Juvenis Juniores e Seniores Light Kempo | Feminine | 19-35 Years | -57 Kg

Final	
013	
	Maria Lopes (AMAVEIRO) DIDN'T SHOW <input type="text"/>
	Susana Sampaio (PREDATOR) <input type="text"/>
016	
	Maria Lopes (AMAVEIRO) DIDN'T SHOW <input type="text"/>
	Bárbara Silva (SPORTING) <input type="text"/>
019	
	Susana Sampaio (PREDATOR) <input type="text" value="4"/> <input type="text" value="4"/> <input type="text" value="5"/>
	Bárbara Silva (SPORTING) <input type="text" value="9"/> <input type="text" value="6"/> <input type="text" value="11"/>

D2 - A1 - Afternoon

1° Bárbara Silva (SPORTING)

2° Susana Sampaio (PREDATOR)

3° Maria Lopes (AMAVEIRO)

Note

NoneAREA: None

Judge 1

Central Referee

Judge 2

C. Nacional de Juvenis Juniores e Seniores

Light Kempo | Feminine | 19-35 Years | -52 Kg

028

Final

Francisca Soeiro (AKCR)

	1	
--	---	--

Sara Rodrigues (GTA)

	10	
--	----	--

D2 - A1 - Afternoon

1° Sara Rodrigues (GTA)

2° Francisca Soeiro (AKCR)

Note

NoneAREA: None

Judge 1

Central Referee

Judge 2

C. Nacional de Juvenis Juniores e Seniores

Light Kempo | Feminine | 36-45 Years | -64 Kg

014

Final

Ivone Rei (GMP)

9 7 9

Sara Lopes (ADKT)

8 6 6

017

Ivone Rei (GMP)

11 5 9

Olga Tasits (UDCAS)

14 7 8

020

Sara Lopes (ADKT)

4 5 4

Olga Tasits (UDCAS)

5 8 5

D2 - A1 - Afternoon

1° Olga Tasits (UDCAS)

2° Ivone Rei (GMP)

3° Sara Lopes (ADKT)

Note

NoneAREA: None

Judge 1

Central Referee

Judge 2

C. Nacional de Juvenis Juniores e Seniores

Light Kempo | Masculine | 41-50 Years | -91 Kg

029

Final

José Barros (TH)

21	13	15
----	----	----

Hélio Alves (GMP)

14	9	6
----	---	---

D2 - A1 - Afternoon

1° José Barros (TH)

2° Hélio Alves (GMP)

Note

No notes

Judge 1

Central Referee

Judge 2

C. Nacional de Juvenis Juniores e Seniores

Light Kempo | Masculine | 19-40 Years | -93 Kg

Final				
012	Gonçalo Santos (MURT)	<input type="text"/>	<input type="text"/>	<input type="text"/>
	Luciano Monteiro (KEMPOAAA)	DIDN'T SHOW		
015	Gonçalo Santos (MURT)	<input type="text"/>	<input type="text"/>	<input type="text"/>
	David Tavares (GMP)	DIDN'T SHOW		
018	Luciano Monteiro (KEMPOAAA)	<input type="text"/>	0	<input type="text"/>
	David Tavares (GMP)	<input type="text"/>	1	<input type="text"/>

D2 - A1 - Afternoon

1° Gonçalo Santos (MURT)

2° David Tavares (GMP)

3° Luciano Monteiro (KEMPOAAA)

Note
No notes

Judge 1

Central Referee

Judge 2

C. Nacional de Juvenis Juniores e Seniores

Light Kempo | Masculine | 19-40 Years | -68 Kg

D2 - A2 - Afternoon

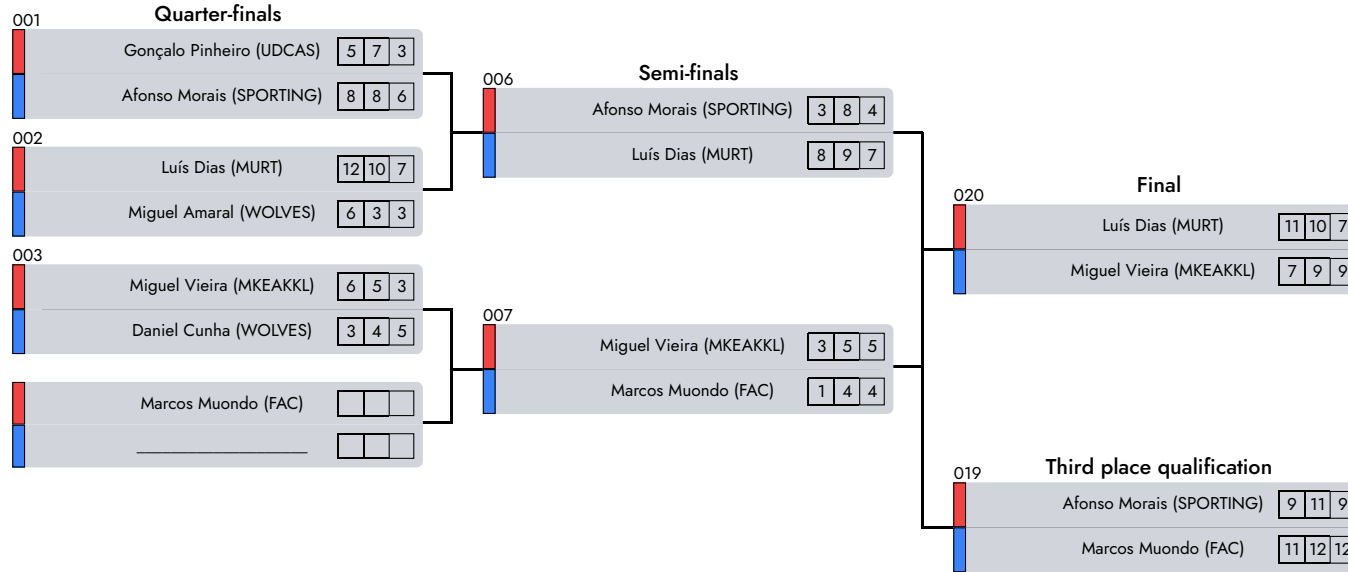

1° Luís Dias (MURT)

2° Miguel Vieira (MKEAKKL)

3° Marcos Muondo (FAC)

Note
 NoneAREA: None

Judge 1

Central Referee

Judge 2

C. Nacional de Juvenis Juniores e Seniores

Light Kempo | Masculine | 19-40 Years | -88 Kg

D2 - A2 - Afternoon

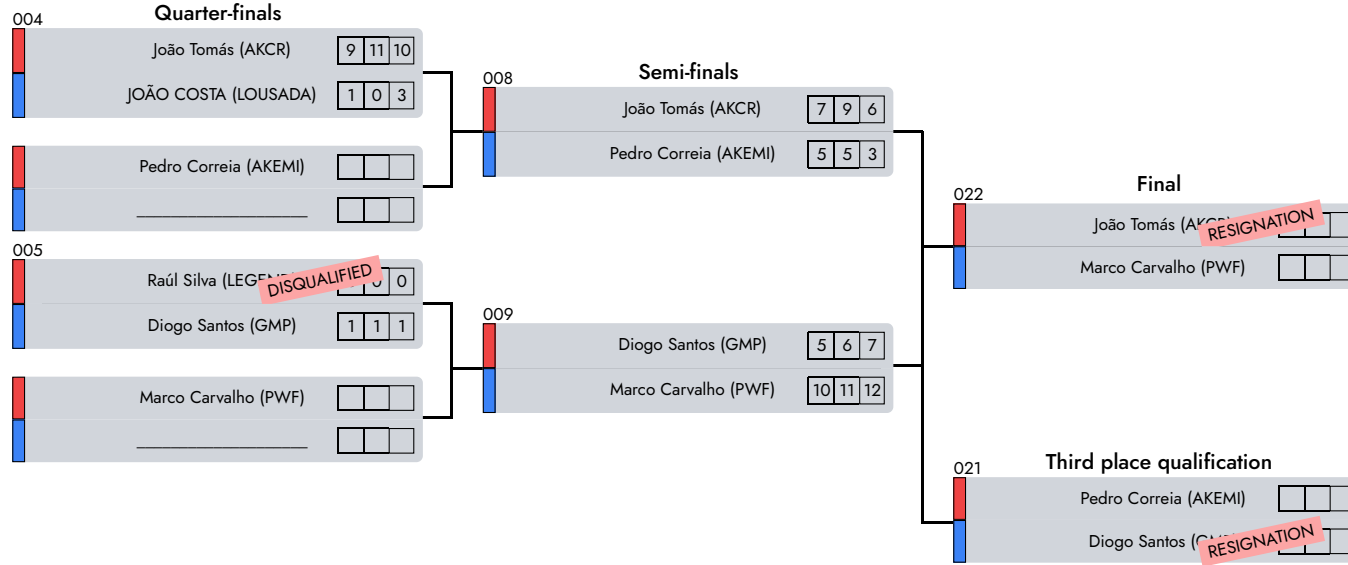

1° Marco Carvalho (PWF)

2° João Tomás (AKCR)

3° Pedro Correia (AKEMI)

Note
NoneAREA: None
AREA: None
AREA: None

Judge 1

Central Referee

Judge 2

C. Nacional de Juvenis Juniores e Seniores

Light Kempo | Feminine | 19-35 Years | +72 Kg

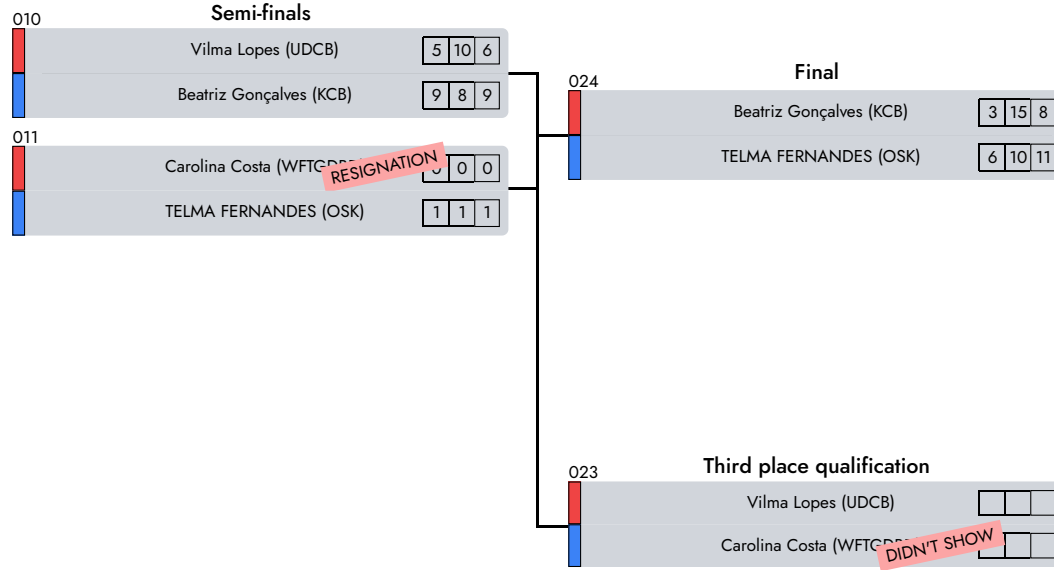

D2 - A2 - Afternoon

1° TELMA FERNANDES (OSK)

2° Beatriz Gonçalves (KCB)

3° Vilma Lopes (UDCB)

Note
NoneAREA: None

Judge 1

Central Referee

Judge 2

C. Nacional de Juvenis Juniores e Seniores

Light Kempo | Masculine | 19-40 Years | -83 Kg

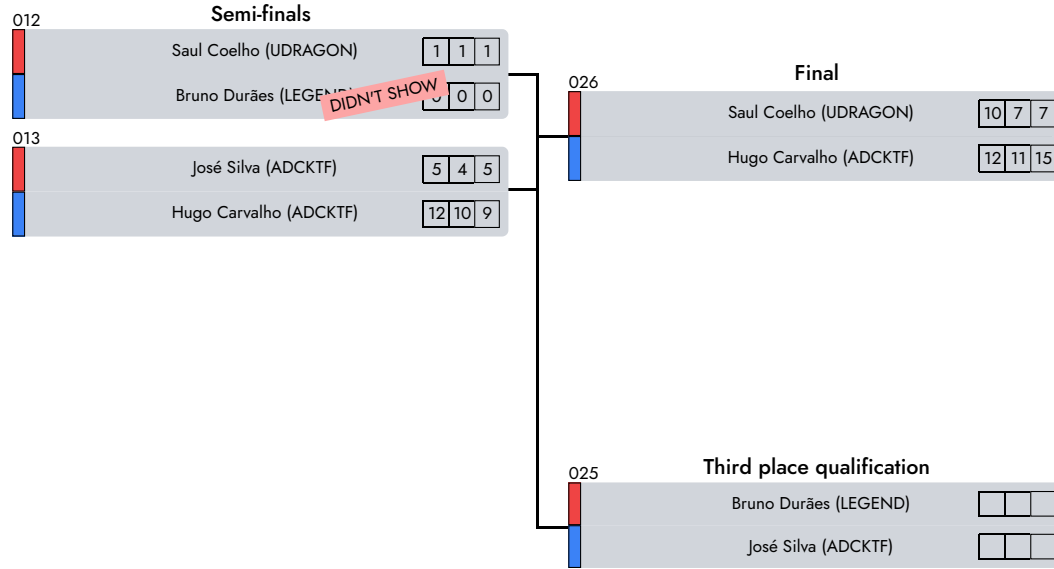

D2 - A2 - Afternoon

1° Hugo Carvalho (ADCKTF)

2° Saul Coelho (UDRAGON)

3° _____

Note
 NoneAREA: None

Judge 1

Central Referee

Judge 2

C. Nacional de Juvenis Juniores e Seniores

Light Kempo | Masculine | 19-40 Years | -78 Kg

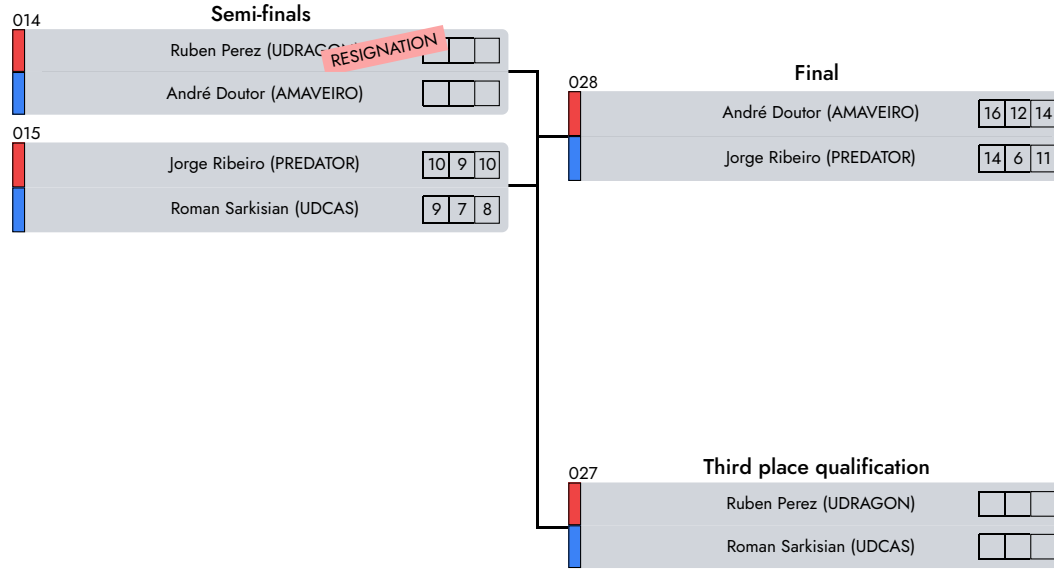

D2 - A2 - Afternoon

1° André Doutor (AMAVEIRO)

2° Jorge Ribeiro (PREDATOR)

3° _____

Note
NoneAREA: None

Judge 1

Central Referee

Judge 2

C. Nacional de Juvenis Juniores e Seniores

Light Kempo | Masculine | 41-50 Years | -73 Kg

Final				
016				
	Rui Cirne (FAC) <table border="1"><tr><td>1</td><td>1</td><td>1</td></tr></table>	1	1	1
1	1	1		
	José Aleixo (UDCAS) <table border="1"><tr><td>0</td><td>0</td><td>0</td></tr></table>	0	0	0
0	0	0		
017				
	José Aleixo (UDCAS) RESIGNATION <table border="1"><tr><td></td><td></td><td></td></tr></table>			
	Pedro Teixeira (MURT) <table border="1"><tr><td></td><td></td><td></td></tr></table>			
018				
	Rui Cirne (FAC) <table border="1"><tr><td>9</td><td>6</td><td>10</td></tr></table>	9	6	10
9	6	10		
	Pedro Teixeira (MURT) <table border="1"><tr><td>16</td><td>18</td><td>15</td></tr></table>	16	18	15
16	18	15		

D2 - A2 - Afternoon

1° Pedro Teixeira (MURT)

2° Rui Cirne (FAC)

3° José Aleixo (UDCAS)

Note
NoneAREA: None

Judge 1

Central Referee

Judge 2

C. Nacional de Juvenis Juniores e Seniores

Light Kempo | Masculine | 51-65 Years | +10 Kg

029

Final

Ricardo Oliveira (WFTSAC)

8	10	11
---	----	----

Fernando leite (LEGEND)

5	3	3
---	---	---

D2 - A2 - Afternoon

1° Ricardo Oliveira (WFTSAC)

2° Fernando leite (LEGEND)

Note

NoneAREA: None

Judge 1

Central Referee

Judge 2

C. Nacional de Juvenis Juniores e Seniores

Full Kempo | Masculine | 14-15 Years | -58 Kg

D2 - A3 - Afternoon

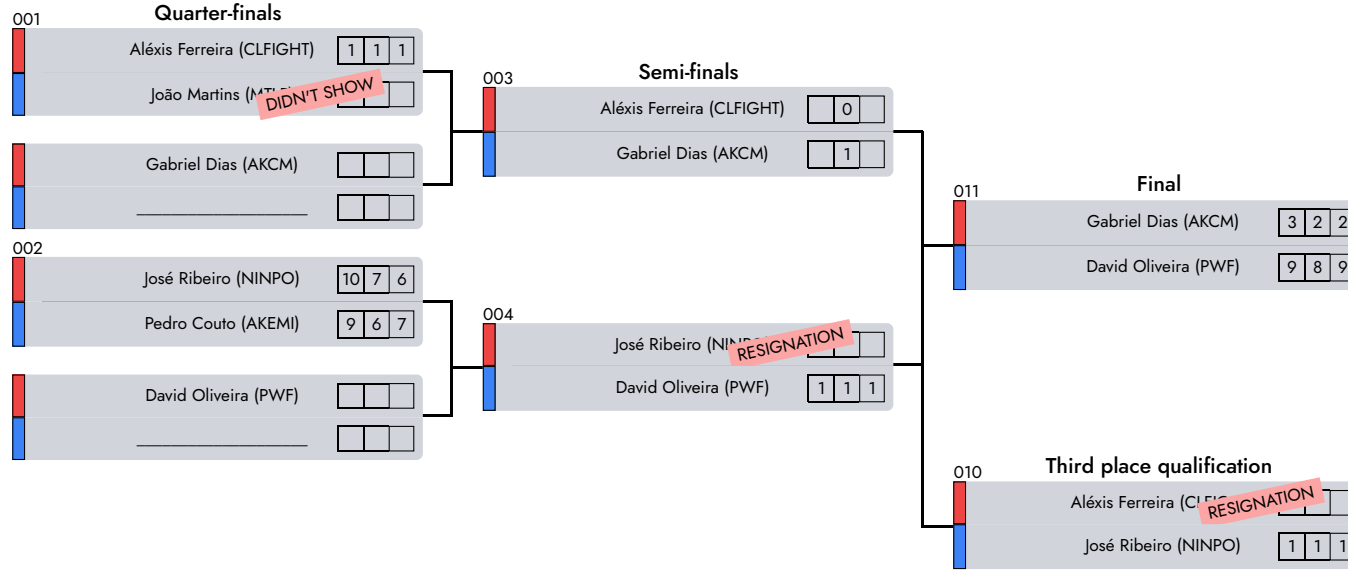

1° David Oliveira (PWF)

2° Gabriel Dias (AKCM)

3° José Ribeiro (NINPO)

Note
 NoneAREA: None

Judge 1

Central Referee

Judge 2

C. Nacional de Juvenis Juniores e Seniores

Full Kempo | Masculine | 16-18 Years | -62 Kg

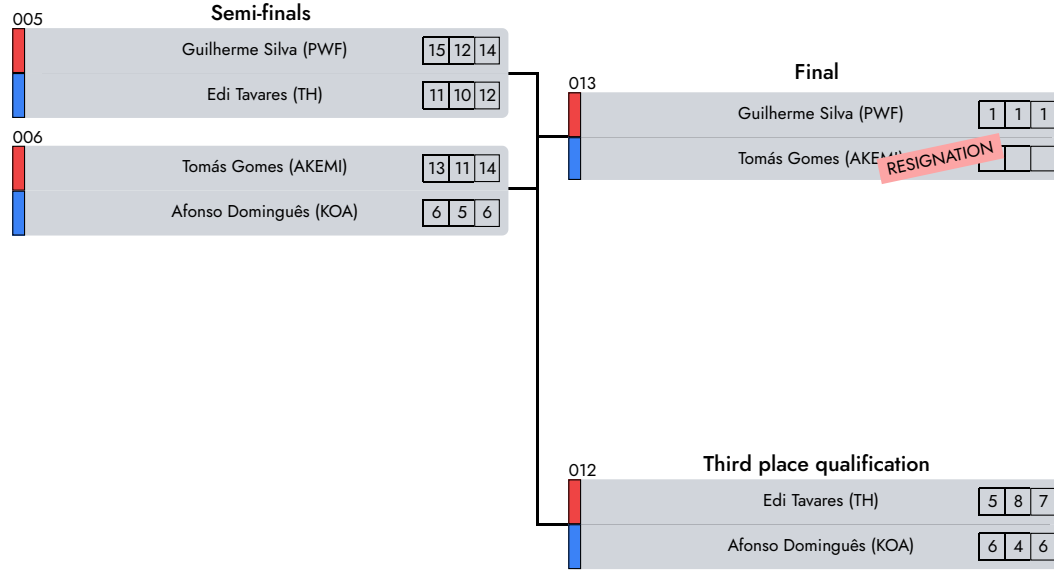

D2 - A3 - Afternoon

1° Guilherme Silva (PWF)

2° Tomás Gomes (AKEMI)

3° Edi Tavares (TH)

Note
NoneAREA: None

Judge 1

Central Referee

Judge 2

C. Nacional de Juvenis Juniores e Seniores

Full Kempo | Masculine | 16-18 Years | -65 Kg

014

Final

Gonçalo Saraiva (AKCR)

8	9	6
---	---	---

Miguel Jacinto (DDA)

9	9	7
---	---	---

D2 - A3 - Afternoon

1° Miguel Jacinto (DDA)

2° Gonçalo Saraiva (AKCR)

Note

NoneAREA: None

Judge 1

Central Referee

Judge 2

C. Nacional de Juvenis Juniores e Seniores

Full Kempo | Masculine | 16-18 Years | -56 Kg

Final	
007	
	José Pereira (KCB) [4][4][4]
	José Fernandes (KCB) [10][10][11]
008	
	José Pereira (KCB) [3][6][5]
	Rúben Teixeira (WFTSAC) [10][11][12]
009	
	José Fernandes (KCB) [1][1][1]
	Rúben Teixeira (WFTSAC) [] [] [] RESIGNATION

D2 - A3 - Afternoon

1° José Fernandes (KCB)

2° Rúben Teixeira (WFTSAC)

3° José Pereira (KCB)

Note

NoneAREA: None

Judge 1

Central Referee

Judge 2

C. Nacional de Juvenis Juniores e Seniores

Full Kempo | Masculine | 16-18 Years | -80 Kg

015

Final

Rodrigo Carvalho (PWF)

1 1 1

Eduardo Sousa (AKKV)

DIDN'T SHOW

D2 - A3 - Afternoon

1° Rodrigo Carvalho (PWF)

2° Eduardo Sousa (AKKV)

Note

NoneAREA: None

Judge 1

Central Referee

Judge 2

C. Nacional de Juvenis Juniores e Seniores

Knock Down | Masculine | 19-40 Years | -85 Kg

Final				
016				
	João Tomás (AKCR) DIDN'T SHOW <table border="1"><tr><td></td><td></td><td></td></tr></table>			
	Vasco Valente (MURT) <table border="1"><tr><td>1</td><td>1</td><td>1</td></tr></table>	1	1	1
1	1	1		
017				
	João Tomás (AKCR) DIDN'T SHOW <table border="1"><tr><td></td><td></td><td></td></tr></table>			
	Diogo Santos (GMP) <table border="1"><tr><td>1</td><td>1</td><td>1</td></tr></table>	1	1	1
1	1	1		
018				
	Vasco Valente (MURT) <table border="1"><tr><td>2</td><td>3</td><td>2</td></tr></table>	2	3	2
2	3	2		
	Diogo Santos (GMP) <table border="1"><tr><td>3</td><td>7</td><td>6</td></tr></table>	3	7	6
3	7	6		

D2 - A3 - Afternoon

1° Diogo Santos (GMP)

2° Vasco Valente (MURT)

3° João Tomás (AKCR)

Note
NoneAREA: None

Judge 1

Central Referee

Judge 2

C. Nacional de Juvenis Juniores e Seniores Knock Down | Masculine | 19-40 Years | -62 Kg

019

Final

Ivo Rodrigues (ADCKTF)

1	2	3
---	---	---

Tiago Teixeira (PREDATOR)

4	6	5
---	---	---

D2 - A3 - Afternoon

1° Tiago Teixeira (PREDATOR)

2° Ivo Rodrigues (ADCKTF)

Note

NoneAREA: None

Judge 1

Central Referee

Judge 2

C. Nacional de Juvenis Juniores e Seniores

Knock Down | Masculine | 16-18 Years | -65 Kg

Final	
020	
	Rui Cunha (ADCKTF) 2 5 4
	Gonçalo Saraiva (AKCR) 1 3 2
021	
	Afonso Fernandes (ADCKTF) 0 0 0
	Rui Cunha (ADCKTF) 1 1 1
022	
	Afonso Fernandes (ADCKTF) 1 1 0
	Gonçalo Saraiva (AKCR) 7 5 6

D2 - A3 - Afternoon

1°	Rui Cunha (ADCKTF)
2°	Gonçalo Saraiva (AKCR)
3°	Afonso Fernandes (ADCKTF)
Note	None
NoneAREA:	None

Judge 1

Central Referee

Judge 2

C. Nacional de Juvenis Juniores e Seniores Knock Down | Masculine | 16-18 Years | -62 Kg

023

Final

Afonso Melim (AKCR)

1 1 1

Afonso Martins (AKKL)

RESIGNATION

D2 - A3 - Afternoon

1°

Afonso Melim (AKCR)

2°

Afonso Martins (AKKL)

Note

NoneAREA: None

Judge 1

Central Referee

Judge 2

C. Nacional de Juvenis Juniores e Seniores Knock Down | Masculine | 19-40 Years | -65 Kg

024

Final

João Lázaro (PREDATOR)

	1	
--	---	--

Fábio Martins (MIKETEAM)

	1	
--	---	--

D2 - A3 - Afternoon

1° Fábio Martins (MIKETEAM)

2° João Lázaro (PREDATOR)

Note

NoneAREA: None

Judge 1

Central Referee

Judge 2

C. Nacional de Juvenis Juniores e Seniores

Knock Down | Masculine | 19-40 Years | -76 Kg

025

Final

Gonçalo Fernandes (MIKETEAM)

	2	
--	---	--

João Oliveira (TH)

	0	
--	---	--

D2 - A3 - Afternoon

1° Gonçalo Fernandes (MIKETEAM)

2° João Oliveira (TH)

Note

NoneAREA: None



Judge 1

Central Referee

Judge 2

C. Nacional de Juvenis Juniores e Seniores

Full Kempo | Masculine | 14-15 Years | -63 Kg

Final				
004				
	Gonçalo Veiga (UDCB) <table border="1"><tr><td>5</td><td>4</td><td>8</td></tr></table>	5	4	8
5	4	8		
	Francisco Costa (UDRAGON) <table border="1"><tr><td>20</td><td>19</td><td>22</td></tr></table>	20	19	22
20	19	22		
006				
	Gonçalo Veiga (UDCB) <table border="1"><tr><td>5</td><td>3</td><td>4</td></tr></table>	5	3	4
5	3	4		
	Rui Cunha (ADCKTF) <table border="1"><tr><td>19</td><td>15</td><td>20</td></tr></table>	19	15	20
19	15	20		
008				
	Francisco Costa (UDRAGON) <table border="1"><tr><td>13</td><td>11</td><td>11</td></tr></table>	13	11	11
13	11	11		
	Rui Cunha (ADCKTF) <table border="1"><tr><td>12</td><td>12</td><td>14</td></tr></table>	12	12	14
12	12	14		

D2 - A4 - Afternoon

1° Rui Cunha (ADCKTF)

2° Francisco Costa (UDRAGON)

3° Gonçalo Veiga (UDCB)

Note

NoneAREA: None

Judge 1

Central Referee

Judge 2

C. Nacional de Juvenis Juniores e Seniores

Full Kempo | Masculine | 14-15 Years | -43 Kg

012

Final

Gabriel Carneiro (UDRAGON)

--	--	--

Simão Domingues (NINPO)

RESIGNATION

--	--	--

D2 - A4 - Afternoon

1° Gabriel Carneiro (UDRAGON)

2° Simão Domingues (NINPO)

Note

NoneAREA: None

Judge 1

Central Referee

Judge 2

C. Nacional de Juvenis Juniores e Seniores

Full Kempo | Feminine | 14-15 Years | -54 Kg

013

Final

Carmo Triães (CBG)

RESIGNATION

--	--	--

Mariana Castro (PREDATOR)

--	--	--

D2 - A4 - Afternoon

1° Mariana Castro (PREDATOR)

2° Carmo Triães (CBG)

Note

NoneAREA: None

Judge 1

Central Referee

Judge 2

C. Nacional de Juvenis Juniores e Seniores

Full Kempo | Masculine | 16-18 Years | -68 Kg

D2 - A4 - Afternoon

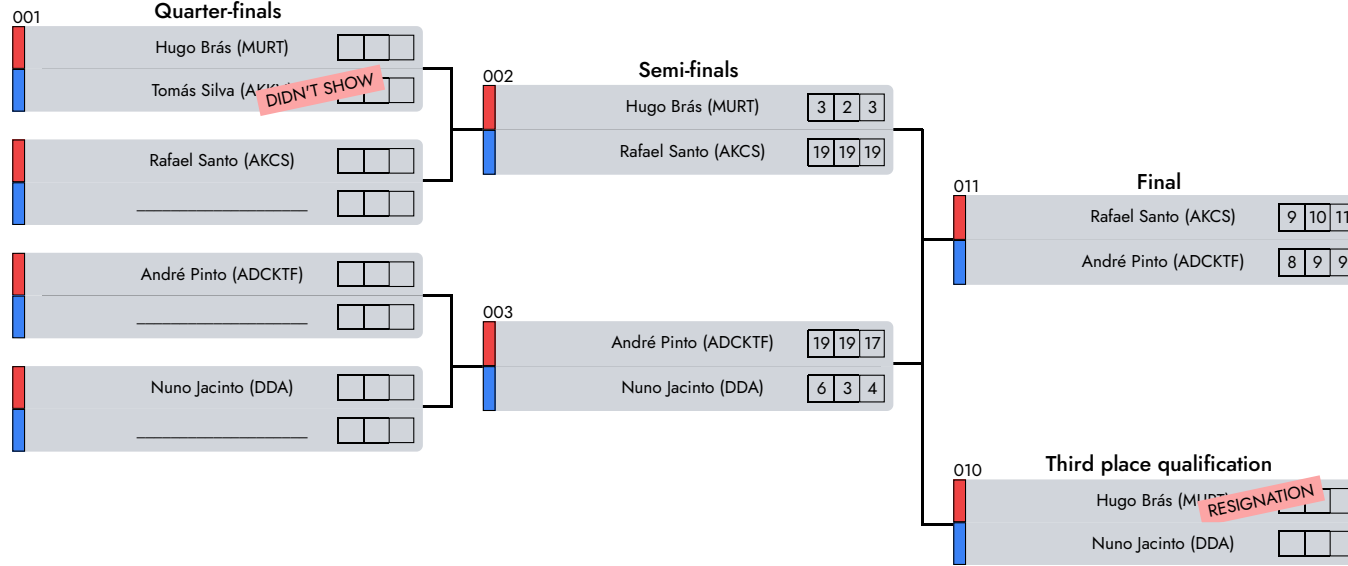

- 1° Rafael Santo (AKCS)
 - 2° André Pinto (ADCKTF)
 - 3° Nuno Jacinto (DDA)
- Note
 NoneAREA: None

Judge 1

Central Referee

Judge 2

C. Nacional de Juvenis Juniores e Seniores

Full Kempo | Masculine | 16-18 Years | -90 Kg

014

Final

Rodrigo Santos (WFTSAC)

4	6	2
---	---	---

António Albuquerque (SPORTING)

5	10	5
---	----	---

D2 - A4 - Afternoon

1° António Albuquerque (SPORTING)

2° Rodrigo Santos (WFTSAC)

Note

NoneAREA: None

Judge 1

Central Referee

Judge 2

C. Nacional de Juvenis Juniores e Seniores

Full Kempo | Masculine | 16-18 Years | -76 Kg

Final	
005	
	João Moreira (AKEMI) <input type="text"/> <input type="text"/> <input type="text"/>
	Angelo Fernandes (ADCKTF) RESIGNATION <input type="text"/> <input type="text"/> <input type="text"/>
007	
	João Moreira (AKEMI) <input type="text"/> 4 <input type="text"/> 1 <input type="text"/> 4
	João Teles (UDCAS) <input type="text"/> 8 <input type="text"/> 5 <input type="text"/> 8
009	
	Angelo Fernandes (ADCKTF) DIDN'T SHOW <input type="text"/> <input type="text"/> <input type="text"/>
	João Teles (UDCAS) <input type="text"/> <input type="text"/> <input type="text"/>

D2 - A4 - Afternoon

1° João Teles (UDCAS)

2° João Moreira (AKEMI)

3° Angelo Fernandes (ADCKTF)

Note

NoneAREA: None

Judge 1

Central Referee

Judge 2

C. Nacional de Juvenis Juniores e Seniores

Full Kempo | Feminine | 16-18 Years | +72 Kg

015

Final

Lara Luís (PWF)

5	7	3
---	---	---

Adriana Marinho (WOLVES)

6	6	5
---	---	---

D2 - A4 - Afternoon

1° Adriana Marinho (WOLVES)

2° Lara Luís (PWF)

Note

NoneAREA: None

Judge 1

Central Referee

Judge 2

C. Nacional de Juvenis Juniores e Seniores Knock Down | Masculine | 19-40 Years | -80 Kg

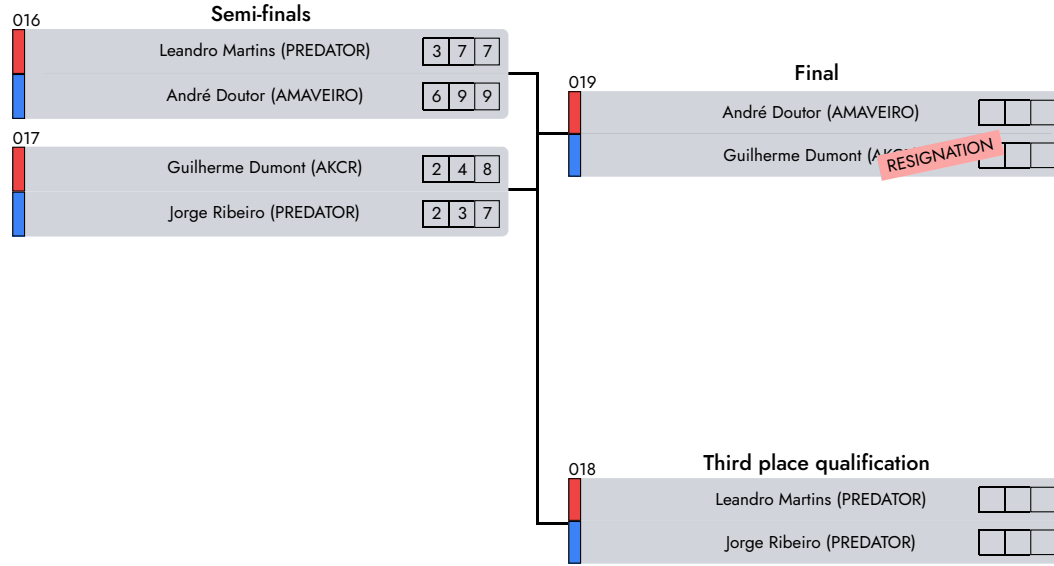

D2 - A4 - Afternoon

1° André Doutor (AMAVEIRO)

2° Guilherme Dumont (AKCR)

3° Jorge Ribeiro (PREDATOR)

Note
NoneAREA: None

Judge 1

Central Referee

Judge 2

C. Nacional de Juvenis Juniores e Seniores Knock Down | Masculine | 16-18 Years | -68 Kg

020

Final

João Andrade (ADCKTF)

--	--	--

André Pinto (ADCKTF)

RESIGNATION

--	--	--

D2 - A4 - Afternoon

1° João Andrade (ADCKTF)

2° André Pinto (ADCKTF)

Note

NoneAREA: None

Judge 1

Central Referee

Judge 2

C. Nacional de Juvenis Juniores e Seniores Knock Down | Feminine | 19-35 Years | -56 Kg

021

Final

Francisca Soeiro (AKCR)

RESIGNATION

--	--	--

Diana Cazanoi (AKCR)

--	--	--

D2 - A4 - Afternoon

1° Diana Cazanoi (AKCR)

2° Francisca Soeiro (AKCR)

Note

NoneAREA: None

AREA: None

Judge 1

Central Referee

Judge 2

C. Nacional de Juvenis Juniores e Seniores

Submission Kempo | Masculine | 16-18 Years | -63 Kg

D2 - A5 - Afternoon

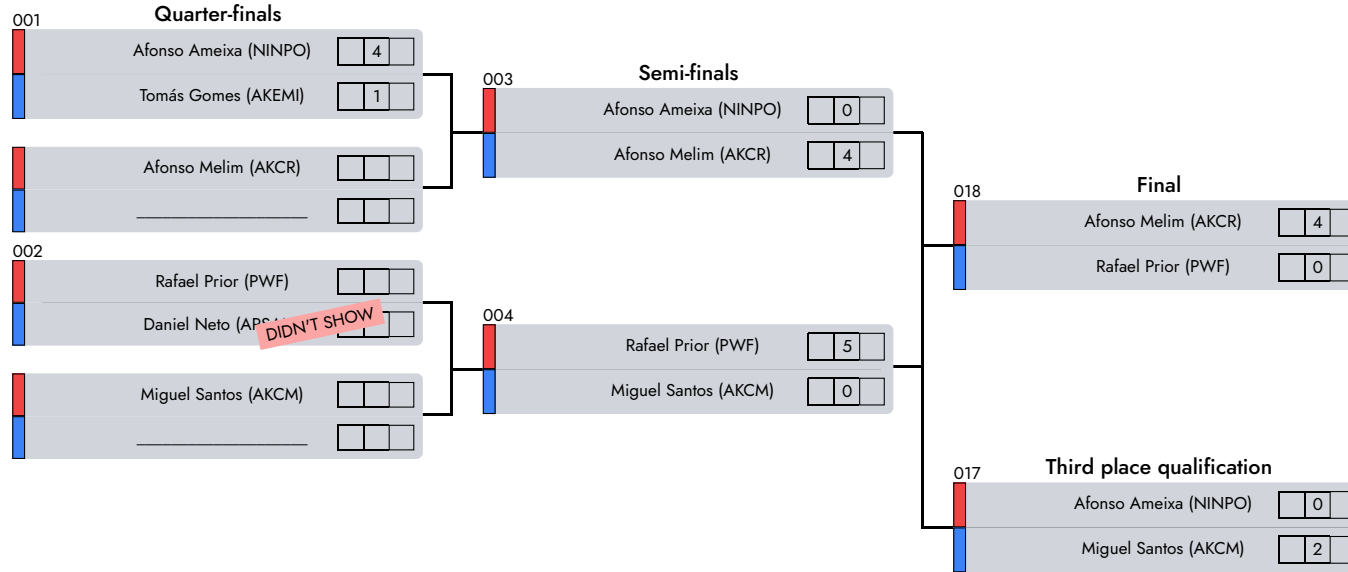

1° Afonso Melim (AKCR)

2° Rafael Prior (PWF)

3° Miguel Santos (AKCM)

Note
 NoneAREA: None

Judge 1

Central Referee

Judge 2

C. Nacional de Juvenis Juniores e Seniores

Submission Kempo | Feminine | 16-18 Years | -57 Kg

Final	
005	
 	
	Maria Pinto (AKEMI) <input type="text" value="4"/>
	Laura Silva (PWF) <input type="text" value="6"/>
009	
 	
	Maria Pinto (AKEMI) <input type="text" value="1"/>
	Sofia Madureira (ADCKTF) <input type="text" value="7"/>
013	
 	
	Sofia Madureira (ADCKTF) <input type="text" value="6"/>
	Laura Silva (PWF) <input type="text" value="0"/>

D2 - A5 - Afternoon

1° Sofia Madureira (ADCKTF)

2° Laura Silva (PWF)

3° Maria Pinto (AKEMI)

Note

NoneAREA: None

Judge 1

Central Referee

Judge 2

C. Nacional de Juvenis Juniores e Seniores

Submission Kempo | Masculine | 16-18 Years | -78 Kg

Final	
006	Francisco Gomes (MURT) <input type="text" value="2"/>
	Angelo Fernandes (ADCKTF) <input type="text" value="3"/>
010	Francisco Gomes (MURT) <input type="text" value="5"/>
	João Moreira (AKEMI) <input type="text" value="4"/>
014	Angelo Fernandes (ADCKTF) <input type="text" value=""/> <i>RESIGNATION</i>
	João Moreira (AKEMI) <input type="text" value=""/>

D2 - A5 - Afternoon

1° Francisco Gomes (MURT)

2° João Moreira (AKEMI)

3° Angelo Fernandes (ADCKTF)

Note

NoneAREA: None

Judge 1

Central Referee

Judge 2

C. Nacional de Juvenis Juniores e Seniores

Submission Kempo | Masculine | 14-15 Years | -53 Kg

Final	
007	Leonardo Rocha (KOA) DIDN'T SHOW <input type="checkbox"/> <input type="checkbox"/> <input type="checkbox"/>
	Alexander Efimochkin (MTLF) <input type="checkbox"/> <input type="checkbox"/> <input type="checkbox"/>
011	Leonardo Rocha (KOA) DIDN'T SHOW <input type="checkbox"/> <input type="checkbox"/> <input type="checkbox"/>
	Rodrigo Oliveira (MURT) <input type="checkbox"/> <input type="checkbox"/> <input type="checkbox"/>
015	Alexander Efimochkin (MTLF) RESIGNATION <input type="checkbox"/> <input type="checkbox"/> <input type="checkbox"/>
	Rodrigo Oliveira (MURT) <input type="checkbox"/> <input type="checkbox"/> <input type="checkbox"/>

D2 - A5 - Afternoon

1° Rodrigo Oliveira (MURT)

2° Alexander Efimochkin (MTLF)

3° Leonardo Rocha (KOA)

Note

NoneAREA: None

Judge 1

Central Referee

Judge 2

C. Nacional de Juvenis Juniores e Seniores

Submission Kempo | Masculine | 14-15 Years | -68 Kg

019

Final

Tomás Homem (KOA)

	2	
--	---	--

Bernardo Caldeira (KOA)

	1	
--	---	--

D2 - A5 - Afternoon

1° Tomás Homem (KOA)

2° Bernardo Caldeira (KOA)

Note

NoneAREA: None

AREA: None

Daniela Santos

Judge 1

Diogo Henriques

Central Referee

Marta Governo

Judge 2

C. Nacional de Juvenis Juniores e Seniores

Submission Kempo | Feminine | 14-15 Years | -49 Kg

008

Final

Carolina Xavier (KOA)

1

Carolina Oliveira (NINPO)

0

012

Carolina Xavier (KOA)

5

Etifania Antonio (NINPO)

2

016

Carolina Oliveira (NINPO)

2

Etifania Antonio (NINPO)

0

D2 - A5 - Afternoon

1° Carolina Xavier (KOA)

2° Carolina Oliveira (NINPO)

3° Etifania Antonio (NINPO)

Note

NoneAREA: None

Judge 1

Central Referee

Judge 2

C. Nacional de Juvenis Juniores e Seniores

Submission Kempo | Feminine | 14-15 Years | -59 Kg

020

Final

Inês Mota (PREDATOR)

6

Maria Oliveira (NINPO)

2

D2 - A5 - Afternoon

1° Inês Mota (PREDATOR)

2° Maria Oliveira (NINPO)

Note
NoneAREA: None

Judge 1

Central Referee

Judge 2

C. Nacional de Juvenis Juniores e Seniores

Submission Kempo | Feminine | 14-15 Years | +64 Kg

021

Final

Nuria Martins (PWF)

--	--	--

Vitoria Doria (NINPO)

	1	
--	---	--

D2 - A5 - Afternoon

1°

Vitoria Doria (NINPO)

2°

Nuria Martins (PWF)

Note

NoneAREA: None

AREA: None

Daniela Santos

Judge 1

Diogo Henriques

Central Referee

Marta Governo

Judge 2

C. Nacional de Juvenis Juniores e Seniores

Submission Kempo | Masculine | 16-18 Years | -68 Kg

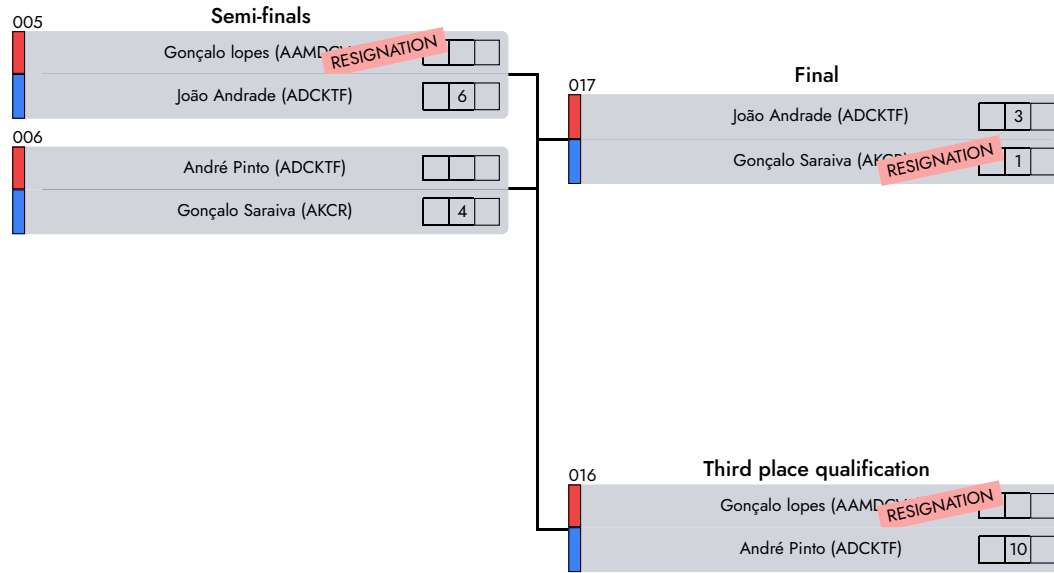

D2 - A6 - Afternoon

1° João Andrade (ADCKTF)

2° Gonçalo Saraiva (AKCR)

3° André Pinto (ADCKTF)

Note
 NoneAREA: None
 AREA: None
 AREA: None

Daniela Santos
 Judge 1

Diogo Henriques
 Central Referee

Marta Governo
 Judge 2

C. Nacional de Juvenis Juniores e Seniores

Submission Kempo | Masculine | 16-18 Years | -58 Kg

Final	
013	Diogo Simplicio (NINPO) <input type="checkbox"/> <input type="checkbox"/> <input type="checkbox"/>
	Rúben Teixeira (WFTSAC) RESIGNATION <input type="checkbox"/> <input type="checkbox"/> <input type="checkbox"/>
014	Diogo Simplicio (NINPO) <input type="checkbox"/> <input type="checkbox"/> <input type="checkbox"/>
	Lucas Rodrigues (AKCR) <input type="checkbox"/> 4 <input type="checkbox"/>
015	Rúben Teixeira (WFTSAC) <input type="checkbox"/> 4 <input type="checkbox"/>
	Lucas Rodrigues (AKCR) <input type="checkbox"/> 2 <input type="checkbox"/>

D2 - A6 - Afternoon

1° Lucas Rodrigues (AKCR)

2° Rúben Teixeira (WFTSAC)

3° Diogo Simplicio (NINPO)

Note

NoneAREA: None

AREA: None

Daniela Santos

Judge 1

Diogo Henriques

Central Referee

Marta Governo

Judge 2

C. Nacional de Juvenis Juniores e Seniores

Submission Kempo | Feminine | 14-15 Years | -54 Kg

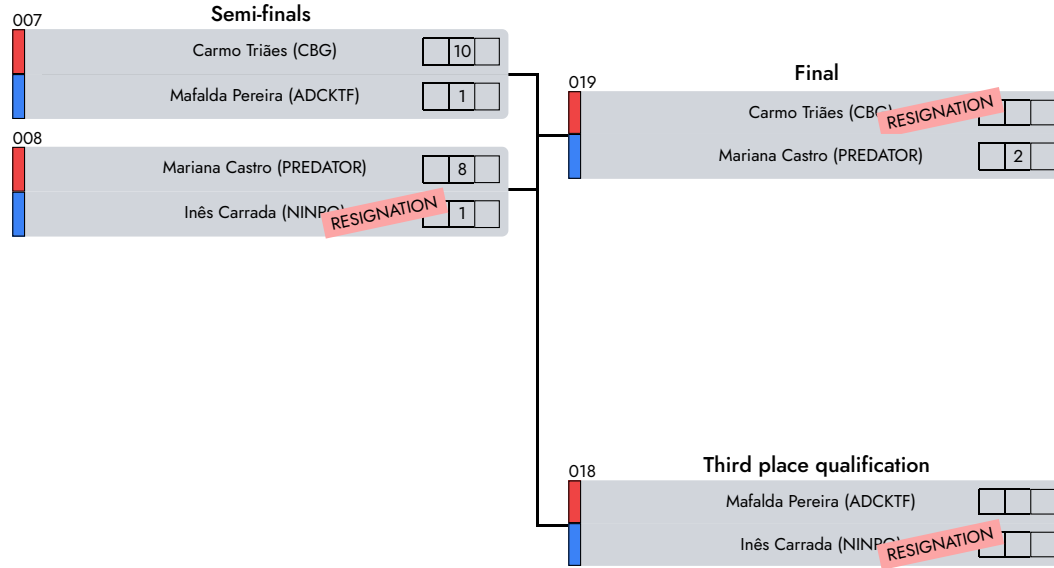

D2 - A6 - Afternoon

1° Mariana Castro (PREDATOR)

2° Carmo Triães (CBG)

3° Mafalda Pereira (ADCKTF)

Note
 NoneAREA: None
 AREA: None
 AREA: None
 AREA: None

Daniela Santos
 Judge 1

Diogo Henriques
 Central Referee

Marta Governo
 Judge 2

C. Nacional de Juvenis Juniores e Seniores

Submission Kempo | Masculine | 14-15 Years | -58 Kg

D2 - A6 - Afternoon

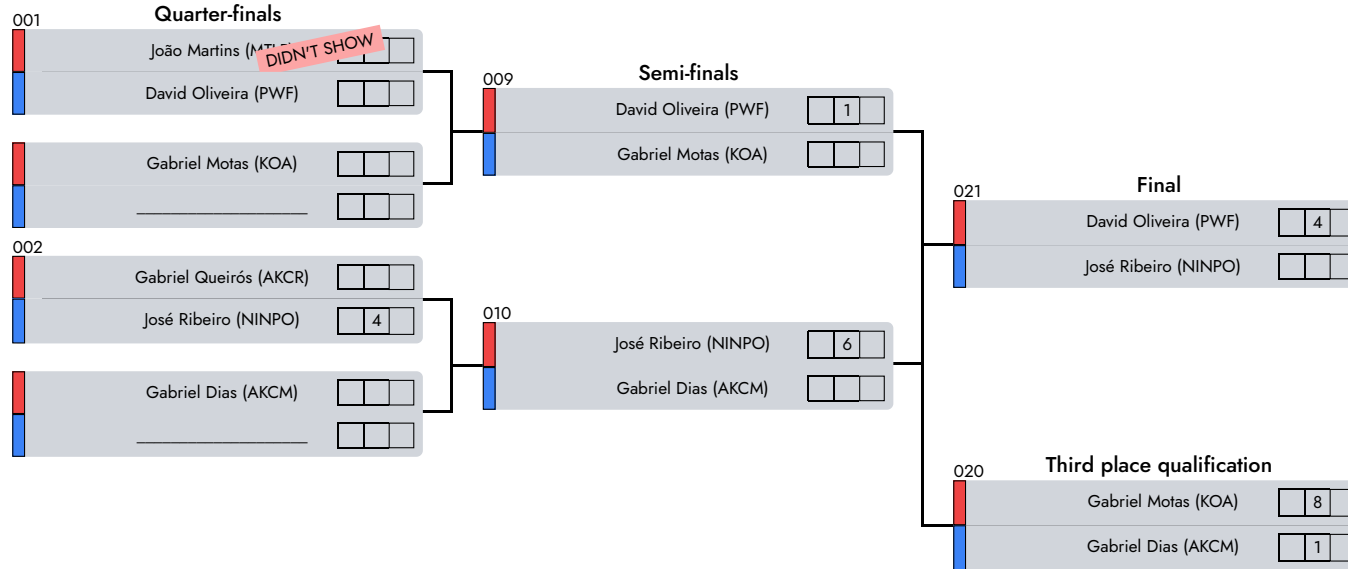

1° David Oliveira (PWF)

2° José Ribeiro (NINPO)

3° Gabriel Motas (KOA)

Note
NoneAREA: None
AREA: None

Daniela Santos

Judge 1

Diogo Henriques

Central Referee

Marta Governo

Judge 2

C. Nacional de Juvenis Juniores e Seniores

Submission Kempo | Masculine | 14-15 Years | -63 Kg

D2 - A6 - Afternoon

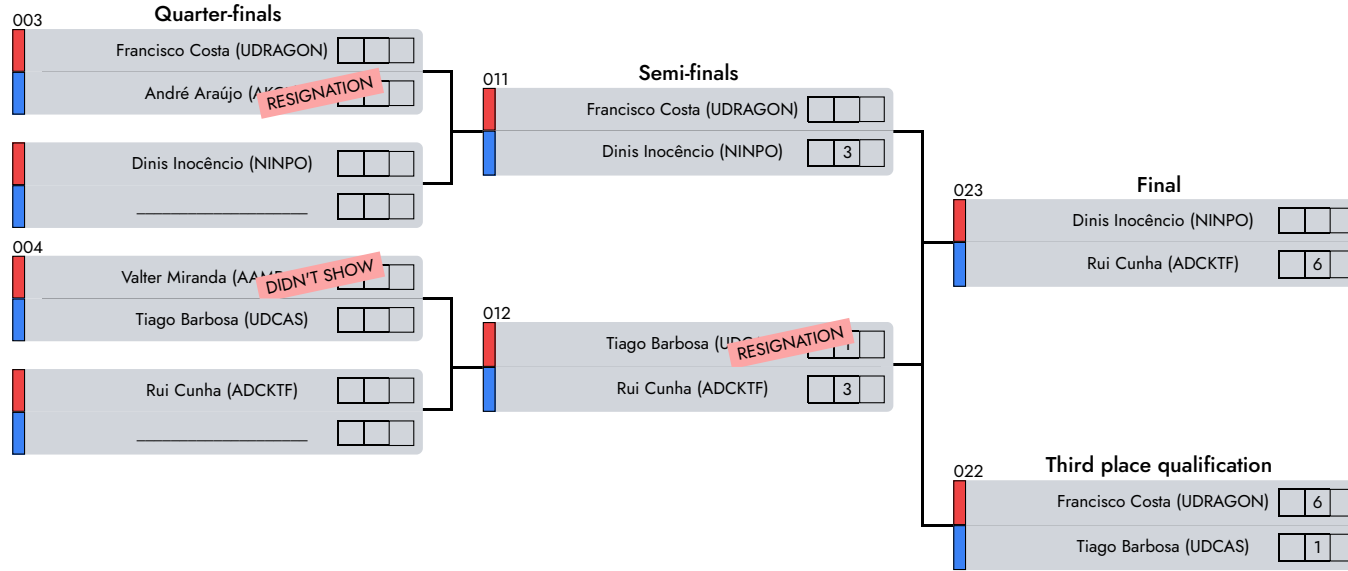

1° Rui Cunha (ADCKTF)

2° Dinis Inocêncio (NINPO)

3° Francisco Costa (UDRAGON)

Note
NoneAREA: None
AREA: None

Daniela Santos

Judge 1

Diogo Henriques

Central Referee

Marta Governo

Judge 2

C. Nacional de Juvenis Juniores e Seniores

Submission Kempo | Masculine | 14-15 Years | -43 Kg

024

Final

Martim Rolo (PWF)

RESIGNATION

2

Simão Domingues (NINPO)

5

D2 - A6 - Afternoon

1° Simão Domingues (NINPO)

2° Martim Rolo (PWF)

Note

NoneAREA: None

AREA: None

Daniela Santos

Judge 1

Diogo Henriques

Central Referee

Marta Governo

Judge 2

C. Nacional de Juvenis Juniores e Seniores

Defesa Pessoal | Open | 30-65 Years

Final

José Cardoso (AKKV)

--	--	--

--	--	--

No area

1°

José Cardoso (AKKV)

Note

No notes

Judge 1

Central Referee

Judge 2

C. Nacional de Juvenis Juniores e Seniores

Knock Down | Masculine | 16-18 Years | -72 Kg

Final

	Daniel Plamadeala (AKCR)	<input type="text"/>	<input type="text"/>	<input type="text"/>
	_____	<input type="text"/>	<input type="text"/>	<input type="text"/>

No area

1°

Daniel Plamadeala (AKCR)

Note

No notes

Judge 1

Central Referee

Judge 2

C. Nacional de Juvenis Juniores e Seniores

Knock Down | Masculine | 19-40 Years | -68 Kg

Final

	Gonçalo Pinheiro (UDCAS)	<input type="text"/>	<input type="text"/>	<input type="text"/>
	_____	<input type="text"/>	<input type="text"/>	<input type="text"/>

No area

1° Gonçalo Pinheiro (UDCAS)

Note
No notes

Judge 1

Central Referee

Judge 2

C. Nacional de Juvenis Juniores e Seniores

Knock Down | Masculine | 19-40 Years | -72 Kg

Final

João Oliveira (TH)

--	--	--

--	--	--

No area

1°

João Oliveira (TH)

Note

No notes

Judge 1

Central Referee

Judge 2

C. Nacional de Juvenis Juniores e Seniores

Knock Down | Masculine | 19-40 Years | -90 Kg

Final

	Gonçalo Santos (MURT)	<input type="text"/>	<input type="text"/>	<input type="text"/>
	_____	<input type="text"/>	<input type="text"/>	<input type="text"/>

No area

1°

Gonçalo Santos (MURT)

Note

No notes

Judge 1

Central Referee

Judge 2

C. Nacional de Juvenis Juniores e Seniores

Submission Kempo | Masculine | 14-15 Years | -48 Kg

Final

Paulo Nazaruk (NINPO)

--	--	--

--	--	--

No area

1°

Paulo Nazaruk (NINPO)

Note

No notes

Judge 1

Central Referee

Judge 2

C. Nacional de Juvenis Juniores e Seniores

Submission Kempo | Masculine | 14-15 Years | -73 Kg

Final

Artur Myhulyak (NINPO)

--	--	--

--	--	--

No area

1°

Artur Myhulyak (NINPO)

Note

No notes

Judge 1

Central Referee

Judge 2

C. Nacional de Juvenis Juniores e Seniores

Submission Kempo | Masculine | 16-18 Years | -53 Kg

No area

1°

Leonardo Lacatus (NINPO)

Final

Leonardo Lacatus (NINPO)

--	--	--

--	--	--

Note

No notes

Judge 1

Central Referee

Judge 2

C. Nacional de Juvenis Juniores e Seniores

Submission Kempo | Masculine | 16-18 Years | -73 Kg

Final

	Daniel Plamadeala (AKCR)	<input type="text"/>	<input type="text"/>	<input type="text"/>
	_____	<input type="text"/>	<input type="text"/>	<input type="text"/>

No area

1° Daniel Plamadeala (AKCR)

Note
No notes

Judge 1

Central Referee

Judge 2

C. Nacional de Juvenis Juniores e Seniores

Submission Kempo | Masculine | 16-18 Years | -88 Kg

Final

Bruno D'Souza (CEFIDEC)

--	--	--

--	--	--

No area

1°

Bruno D'Souza (CEFIDEC)

Note

No notes

Judge 1

Central Referee

Judge 2

C. Nacional de Juvenis Juniores e Seniores
Submission Kempo | Masculine | 19-40 Years | +93 Kg

No area

1° Jeferson Moreira (ADCKTF)

Final

Jeferson Moreira (ADCKTF)

--	--	--

--	--	--

Note
No notes

Judge 1

Central Referee

Judge 2

C. Nacional de Juvenis Juniores e Seniores

Submission Kempo | Masculine | 19-40 Years | -53 Kg

No area

1°

Abílio Coelho (MIKETEAM)

Final

Abílio Coelho (MIKETEAM)

--	--	--

--	--	--

Note

No notes

Judge 1

Central Referee

Judge 2

C. Nacional de Juvenis Juniores e Seniores
Submission Kempo | Masculine | 41-50 Years | -67 Kg

No area

1°

Pedro Teixeira (MURT)

Final

Pedro Teixeira (MURT)

--	--	--

--	--	--

Note

No notes

Judge 1

Central Referee

Judge 2

C. Nacional de Juvenis Juniores e Seniores
Submission Kempo | Masculine | 41-50 Years | -91 Kg

Final

Hélio Alves (GMP)

--	--	--

--	--	--

No area

1°

Hélio Alves (GMP)

Note

No notes

Judge 1

Central Referee

Judge 2

C. Nacional de Juvenis Juniores e Seniores
Submission Kempo | Feminine | 14-15 Years | -64 Kg

No area

1°

Leonor Alves (GMP)

Final

Leonor Alves (GMP)

--	--	--

--	--	--

Note

No notes

Judge 1

Central Referee

Judge 2

C. Nacional de Juvenis Juniores e Seniores

Submission Kempo | Feminine | 16-18 Years | -52 Kg

No area

1°

Leonor Sousa (AKCM)

Final

Leonor Sousa (AKCM)

--	--	--

--	--	--

Note

No notes

Judge 1

Central Referee

Judge 2

C. Nacional de Juvenis Juniores e Seniores
Submission Kempo | Feminine | 16-18 Years | -62 Kg

Final

Diana Cazanoi (AKCR)

--	--	--

--	--	--

No area

1°

Diana Cazanoi (AKCR)

Note

No notes

Judge 1

Central Referee

Judge 2

C. Nacional de Juvenis Juniores e Seniores

Submission Kempo | Feminine | 19-35 Years | -62 Kg

No area

1°

Beatriz Marques (UDCAS)

Final

Beatriz Marques (UDCAS)

--	--	--

--	--	--

Note

No notes

Judge 1

Central Referee

Judge 2

C. Nacional de Juvenis Juniores e Seniores
Submission Kempo | Feminine | 19-35 Years | -72 Kg

No area

1°

Marta Coelho (ADKT)

Final

Marta Coelho (ADKT)

--	--	--

--	--	--

Note

No notes

Judge 1

Central Referee

Judge 2

C. Nacional de Juvenis Juniores e Seniores

Semi Kempo | Masculine | 14-15 Years | -73 Kg

Final

	Artur Myhulyak (NINPO)	<input type="text"/>	<input type="text"/>	<input type="text"/>
	_____	<input type="text"/>	<input type="text"/>	<input type="text"/>

No area

1° Artur Myhulyak (NINPO)

Note
No notes

Judge 1

Central Referee

Judge 2

C. Nacional de Juvenis Juniores e Seniores

Semi Kempo | Masculine | 16-18 Years | -83 Kg

Final

	Daniel Guedes (GTA)			

No area

1°

Daniel Guedes (GTA)

Note

No notes

Judge 1

Central Referee

Judge 2

C. Nacional de Juvenis Juniores e Seniores

Semi Kempo | Masculine | 16-18 Years | -93 Kg

Final

	Rodrigo Santos (WFTSAC)	<input type="text"/>	<input type="text"/>	<input type="text"/>
	_____	<input type="text"/>	<input type="text"/>	<input type="text"/>

No area

1° Rodrigo Santos (WFTSAC)

Note
No notes

Judge 1

Central Referee

Judge 2

C. Nacional de Juvenis Juniores e Seniores

Semi Kempo | Masculine | 19-40 Years | +93 Kg

Final

	Luis Faria (ADCKTF)	<input type="text"/>	<input type="text"/>	<input type="text"/>
	_____	<input type="text"/>	<input type="text"/>	<input type="text"/>

No area

1°

Luis Faria (ADCKTF)

Note

No notes

Judge 1

Central Referee

Judge 2

C. Nacional de Juvenis Juniores e Seniores

Semi Kempo | Masculine | 19-40 Years | -58 Kg

Final

José Lima (MURT)

--	--	--

--	--	--

No area

1°

José Lima (MURT)

Note

No notes

Judge 1

Central Referee

Judge 2

C. Nacional de Juvenis Juniores e Seniores

Semi Kempo | Masculine | 19-40 Years | -93 Kg

Final

Eduardo Silva (PWF)

--	--	--

--	--	--

No area

1°

Eduardo Silva (PWF)

Note

No notes

Judge 1

Central Referee

Judge 2

C. Nacional de Juvenis Juniores e Seniores
Semi Kempo | Masculine | 41-50 Years | -67 Kg

Final

	Pedro Teixeira (MURT)	<input type="text"/>	<input type="text"/>	<input type="text"/>
	_____	<input type="text"/>	<input type="text"/>	<input type="text"/>

No area

1° Pedro Teixeira (MURT)

Note
No notes

Judge 1

Central Referee

Judge 2

C. Nacional de Juvenis Juniores e Seniores

Semi Kempo | Feminine | 14-15 Years | -45 Kg

Final

	Leonor Monteiro (AKCM)	<input type="text"/>	<input type="text"/>	<input type="text"/>
	_____	<input type="text"/>	<input type="text"/>	<input type="text"/>

No area

1° Leonor Monteiro (AKCM)

Note
No notes

Judge 1

Central Referee

Judge 2

C. Nacional de Juvenis Juniores e Seniores

Semi Kempo | Feminine | 36-45 Years | -64 Kg

Final

Olga Tasits (UDCAS)

--	--	--

--	--	--

No area

1°

Olga Tasits (UDCAS)

Note

No notes

Judge 1

Central Referee

Judge 2

C. Nacional de Juvenis Juniores e Seniores

Semi Kempo | Feminine | 46-65 Years | +10 Kg

Final

Ana Assis (AKCS)

--	--	--

--	--	--

No area

1°

Ana Assis (AKCS)

Note

No notes

Judge 1

Central Referee

Judge 2

C. Nacional de Juvenis Juniores e Seniores

Kempo Desportivo Adaptado | Masculine | 12-15 Years | +73 Kg

Final

	Francisco Simões (AKCR)	<input type="text"/>	<input type="text"/>	<input type="text"/>
	_____	<input type="text"/>	<input type="text"/>	<input type="text"/>

No area

1° Francisco Simões (AKCR)

Note
No notes

Judge 1

Central Referee

Judge 2

C. Nacional de Juvenis Juniores e Seniores

Kempo Desportivo Adaptado | Masculine | 12-15 Years | -31 Kg

No area

1°

Leonardo Tavares (CKAFP)

Final

Leonardo Tavares (CKAFP)

--	--	--

--	--	--

Note

No notes

Judge 1

Central Referee

Judge 2

C. Nacional de Juvenis Juniores e Seniores

Kempo Desportivo Adaptado | Masculine | 12-15 Years | -41 Kg

Final

João Jorge (AKCRM)

--	--	--

--	--	--

No area

1°

João Jorge (AKCRM)

Note

No notes

Judge 1

Central Referee

Judge 2

C. Nacional de Juvenis Juniores e Seniores

Kempo Desportivo Adaptado | Feminine | 12-15 Years | -34 Kg

Final

	Irina Pereira (UDCAS)	<input type="text"/>	<input type="text"/>	<input type="text"/>
	_____	<input type="text"/>	<input type="text"/>	<input type="text"/>

No area

1°

Irina Pereira (UDCAS)

Note

No notes

Judge 1

Central Referee

Judge 2

C. Nacional de Juvenis Juniores e Seniores

Formas de Mão Vazia Adaptado | Feminine | 11-13 Years

Final

Irina Pereira (UDCAS)

--	--	--

--	--	--

No area

1°

Irina Pereira (UDCAS)

Note

No notes

Judge 1

Central Referee

Judge 2

C. Nacional de Juvenis Juniores e Seniores

Light Kempo | Masculine | 14-15 Years | -48 Kg

Final

	Paulo Nazaruk (NINPO)	<input type="text"/>	<input type="text"/>	<input type="text"/>
	_____	<input type="text"/>	<input type="text"/>	<input type="text"/>

No area

1°

Paulo Nazaruk (NINPO)

Note

No notes

Judge 1

Central Referee

Judge 2

C. Nacional de Juvenis Juniores e Seniores

Light Kempo | Masculine | 14-15 Years | -73 Kg

Final

	Artur Myhulyak (NINPO)	<input type="text"/>	<input type="text"/>	<input type="text"/>
	_____	<input type="text"/>	<input type="text"/>	<input type="text"/>

No area

1° Artur Myhulyak (NINPO)

Note
No notes

Judge 1

Central Referee

Judge 2

C. Nacional de Juvenis Juniores e Seniores

Light Kempo | Masculine | 16-18 Years | -48 Kg

Final

	Guilherme Rocha (UDCAS)	<input type="text"/>	<input type="text"/>	<input type="text"/>
	_____	<input type="text"/>	<input type="text"/>	<input type="text"/>

No area

1°

Guilherme Rocha (UDCAS)

Note

No notes

Judge 1

Central Referee

Judge 2

C. Nacional de Juvenis Juniores e Seniores

Light Kempo | Masculine | 16-18 Years | -93 Kg

Final

	Rodrigo Santos (WFTSAC)			

No area

1° Rodrigo Santos (WFTSAC)

Note
No notes

Judge 1

Central Referee

Judge 2

C. Nacional de Juvenis Juniores e Seniores
Light Kempo | Masculine | 19-40 Years | +93 Kg

Final

	Luis Faria (ADCKTF)	<input type="text"/>	<input type="text"/>	<input type="text"/>
	_____	<input type="text"/>	<input type="text"/>	<input type="text"/>

No area

1°

Luis Faria (ADCKTF)

Note

No notes

Judge 1

Central Referee

Judge 2

C. Nacional de Juvenis Juniores e Seniores

Light Kempo | Masculine | 19-40 Years | -58 Kg

Final

José Lima (MURT)

--	--	--

--	--	--

No area

1°

José Lima (MURT)

Note

No notes

Judge 1

Central Referee

Judge 2

C. Nacional de Juvenis Juniores e Seniores

Light Kempo | Masculine | 41-50 Years | -67 Kg

Final

	Pedro Teixeira (MURT)	<input type="text"/>	<input type="text"/>	<input type="text"/>
	_____	<input type="text"/>	<input type="text"/>	<input type="text"/>

No area

1°

Pedro Teixeira (MURT)

Note

No notes

Judge 1

Central Referee

Judge 2

C. Nacional de Juvenis Juniores e Seniores
Light Kempo | Masculine | 41-50 Years | -79 Kg

No area

1°

Luciano Gabriel (KEMPOAAA)

Final

Luciano Gabriel (KEMPOAAA)

--	--	--

--	--	--

Note

No notes

Judge 1

Central Referee

Judge 2

C. Nacional de Juvenis Juniores e Seniores

Light Kempo | Masculine | 41-50 Years | -85 Kg

Final

	ANDRE SOUSA (LOUSADA)	<input type="text"/>	<input type="text"/>	<input type="text"/>
	_____	<input type="text"/>	<input type="text"/>	<input type="text"/>

No area

1° ANDRE SOUSA (LOUSADA)

Note
No notes

Judge 1

Central Referee

Judge 2

C. Nacional de Juvenis Juniores e Seniores

Light Kempo | Feminine | 19-35 Years | -72 Kg

Final

	Sara Costa (AKKV)			

No area

1°

Sara Costa (AKKV)

Note

No notes

Judge 1

Central Referee

Judge 2

C. Nacional de Juvenis Juniores e Seniores

Formas c/ Armas Adaptado | Masculine | 14-15 Years

No area

1°

Francisco Simões (AKCR)

Final

Francisco Simões (AKCR)

--	--	--

--	--	--

Note

No notes

Judge 1

Central Referee

Judge 2

C. Nacional de Juvenis Juniores e Seniores

Formas c/ Armas Adaptado | Masculine | 16-17 Years

Final



André Santos (AKCR)

--	--	--

Miguel Santos (AKCR)

--	--	--

No area

1°

2°

Note

No notes

Judge 1

Central Referee

Judge 2

C. Nacional de Juvenis Juniores e Seniores

Formas c/ Armas Adaptado | Feminine | 11-13 Years

Final

Irina Pereira (UDCAS)

--	--	--

--	--	--

No area

1°

Irina Pereira (UDCAS)

Note

No notes

Judge 1

Central Referee

Judge 2

C. Nacional de Juvenis Juniores e Seniores

Full Kempo | Masculine | 14-15 Years | -48 Kg

Final

	Paulo Nazaruk (NINPO)	<input type="text"/>	<input type="text"/>	<input type="text"/>
	_____	<input type="text"/>	<input type="text"/>	<input type="text"/>

No area

1°

Paulo Nazaruk (NINPO)

Note

No notes

Judge 1

Central Referee

Judge 2

C. Nacional de Juvenis Juniores e Seniores

Full Kempo | Masculine | 14-15 Years | -68 Kg

Final

	Francisco Teixeira (UDRAGON)	<input type="text"/>	<input type="text"/>	<input type="text"/>
	_____	<input type="text"/>	<input type="text"/>	<input type="text"/>

No area

1° Francisco Teixeira (UDRAGON)

Note
No notes

Judge 1

Central Referee

Judge 2

C. Nacional de Juvenis Juniores e Seniores

Full Kempo | Masculine | 14-15 Years | -73 Kg

Final

Artur Myhulyak (NINPO)

--	--	--

--	--	--

No area

1°

Artur Myhulyak (NINPO)

Note

No notes

Judge 1

Central Referee

Judge 2

C. Nacional de Juvenis Juniores e Seniores

Full Kempo | Masculine | 16-18 Years | -59 Kg

Final

	Afonso Ferreira (MKEAKKL)	<input type="text"/>	<input type="text"/>	<input type="text"/>
	_____	<input type="text"/>	<input type="text"/>	<input type="text"/>

No area

1°

Afonso Ferreira (MKEAKKL)

Note

No notes

Judge 1

Central Referee

Judge 2

C. Nacional de Juvenis Juniores e Seniores

Full Kempo | Masculine | 19-40 Years | -50 Kg

Final

	Abílio Coelho (MIKETEAM)	<input type="text"/>	<input type="text"/>	<input type="text"/>
	_____	<input type="text"/>	<input type="text"/>	<input type="text"/>

No area

1° Abílio Coelho (MIKETEAM)

Note
No notes

Judge 1

Central Referee

Judge 2

C. Nacional de Juvenis Juniores e Seniores

Full Kempo | Masculine | 19-40 Years | -59 Kg

Final

	José Lima (MURT)	□	□	□
		□	□	□

No area

1°

José Lima (MURT)

Note

No notes

Judge 1



Central Referee

Judge 2

C. Nacional de Juvenis Juniores e Seniores

Full Kempo | Feminine | 14-15 Years | -59 Kg

Final

	Inês Mota (PREDATOR)	<input type="text"/>	<input type="text"/>	<input type="text"/>
	_____	<input type="text"/>	<input type="text"/>	<input type="text"/>

No area

1°

Inês Mota (PREDATOR)

Note

No notes

Judge 1

Central Referee

Judge 2

C. Nacional de Juvenis Juniores e Seniores

Full Kempo | Feminine | 16-18 Years | -47 Kg

Final

<div style="background-color: red; width: 10px; height: 20px; margin-bottom: 5px;"></div> <div style="background-color: blue; width: 10px; height: 20px;"></div>	Maria Albuquerque (SPORTING)	<table border="1"><tr><td style="width: 20px; height: 20px;"></td><td style="width: 20px; height: 20px;"></td><td style="width: 20px; height: 20px;"></td></tr></table>			
	_____	<table border="1"><tr><td style="width: 20px; height: 20px;"></td><td style="width: 20px; height: 20px;"></td><td style="width: 20px; height: 20px;"></td></tr></table>			

No area

1° Maria Albuquerque (SPORTING)

Note
No notes

Judge 1

Central Referee

Judge 2

C. Nacional de Juvenis Juniores e Seniores

Full Kempo | Feminine | 16-18 Years | -53 Kg

Final

	Leonor Sousa (AKCM)	<input type="text"/>	<input type="text"/>	<input type="text"/>
	_____	<input type="text"/>	<input type="text"/>	<input type="text"/>

No area

1°

Leonor Sousa (AKCM)

Note

No notes

Judge 1

Central Referee

Judge 2

C. Nacional de Juvenis Juniores e Seniores

Full Kempo | Feminine | 16-18 Years | -56 Kg

Final

Sofia Madureira (ADCKTF)

--	--	--

--	--	--

No area

1°

Sofia Madureira (ADCKTF)

Note

No notes

Judge 1

Central Referee

Judge 2

C. Nacional de Juvenis Juniores e Seniores

Full Kempo | Feminine | 16-18 Years | -68 Kg

Final

	Diana Barbosa (AKEMI)	<input type="text"/>	<input type="text"/>	<input type="text"/>
	_____	<input type="text"/>	<input type="text"/>	<input type="text"/>

No area

1° Diana Barbosa (AKEMI)

Note
No notes

Judge 1

Central Referee

Judge 2

C. Nacional de Juvenis Juniores e Seniores

Full Kempo | Feminine | 19-35 Years | -47 Kg

Final

Francisca Soeiro (AKCR)

--	--	--

--	--	--

No area

1°

Note

No notes

Judge 1

Central Referee

Judge 2

C. Nacional de Juvenis Juniores e Seniores

Full Kempo | Feminine | 19-35 Years | -50 Kg

Final

	Joana Mortágua (AKCCTST)			

No area

1° Joana Mortágua (AKCCTST)

Note
No notes

Judge 1

Central Referee

Judge 2

C. Nacional de Juvenis Juniores e Seniores

Full Kempo | Feminine | 19-35 Years | -56 Kg

Final

	Tatiana Aleixo (UDCAS)	<input type="text"/>	<input type="text"/>	<input type="text"/>
	_____	<input type="text"/>	<input type="text"/>	<input type="text"/>

No area

1°

Tatiana Aleixo (UDCAS)

Note

No notes

Judge 1



Central Referee

Judge 2

C. Nacional de Juvenis Juniores e Seniores

Full Kempo | Feminine | 19-35 Years | -59 Kg

Final

	Bárbara Silva (SPORTING)	<input type="text"/>	<input type="text"/>	<input type="text"/>
	_____	<input type="text"/>	<input type="text"/>	<input type="text"/>

No area

1° Bárbara Silva (SPORTING)

Note
No notes

Judge 1

Central Referee

Judge 2

C. Nacional de Juvenis Juniores e Seniores

Full Kempo | Feminine | 19-35 Years | -62 Kg

Final

	Carolina Carneiro (UDRAGON)	<input type="text"/>	<input type="text"/>	<input type="text"/>
	_____	<input type="text"/>	<input type="text"/>	<input type="text"/>

No area

1° Carolina Carneiro (UDRAGON)

Note
No notes

Judge 1

Central Referee

Judge 2

